

HW150ACR HW170ACR

WHEELED EXCAVATOR



SERIES / HW150ACR HW170ACR

Gross Power
129 kW (173 hp) at 2200 rpm

Bucket Capacity
0.70 ~ 1.05 m³

Net Power
127 kW (170 hp) at 2200 rpm

Operating Weight
17170 kg & 18820 kg

READY TO CHANGE YOUR WORLD

A

SERIES HW150A_{CR} HW170A_{CR}



Our new A-Series HW150A CR and HW170A CR are ready to build your world. The 4 cylinder Cummins B4.5 Stage V engine is perfectly balanced to deliver 129kW (173hp) with unmatched efficiency. Featuring a new tough exterior design with added safety features and a host of new cab features, you can rely the HW150A CR and HW170A CR to provide maximum mobility and productivity on the toughest construction sites and infrastructure projects.

THE BEST PRODUCTIVITY AND FUEL EFFICIENCY

From its upgraded, eco-friendly engine to its carefully chosen control technologies, the HW150A CR and HW170A CR wheeled excavators help operators to achieve new heights of productivity. Hyundai's LUDV (Advanced Load Sensing) hydraulic system, combined with attachment flow control, ECO Gauge and proportional joysticks and pedal control, enables the machine to deliver the exact performance and efficiency when and where it's needed.

EU Stage V Certified Engine

Now in its fourth decade of continuous improvement, the B4.5 Cummins engine features an EGR-free design for increased fuel economy and longer maintenance intervals, contributing to a reduced cost of operation.



The Cummins B4.5 engine satisfies the strictest environmental emission regulation in the world including a 60% reduction in Particulate Matter (PM).



The technology to improve efficiency

Load sensing hydraulics

The HW A-Series features Hyundai's LUDV Load Sensing hydraulic system. This allows for multi-functional operation and precise machine movements. Control is smooth and predictable, even with a demanding workload. By delivering power exactly when needed, the system also contributes to fuel savings.

Reversible fan

The HW A Series provides excellent cooling performance by increasing heat dissipation and reducing downtime caused by overheating.

Eco gauge

Helps operators to reduce emissions and running costs by constantly monitoring efficiency. It displays engine workload and fuel-saving status while the machine is working.



Eco Gauge

A true compact radius for enhanced manoeuvrability. Ultra-short rear swing radius enables the HW A CR Series wheeled excavators to work on narrow construction sites.



Carriage versatility ▲

Both blade and dozer are interchangeable on the front and rear. With its hitch preparation kit, the HW A-Series is also trailer hitch ready.

Attachment flow control ▶

The HW A Series optimizes attachments for effective flow rate setting depending on attachments (ten breaker types and ten crusher types), enabling various operations matching the site environments.

Fuel rate information

Fuel information is displayed as average rate and latest fuel consumed, for guidance to economical operating.

Engine auto-idle

The auto-idle feature saves fuel, reduces noise and cuts exhaust emissions by automatically switching the engine to idle setting when the excavator is inactive.

UP TO
11% EFFICIENCY
(Compared to previous model)



NEW EXTERIOR DESIGN FOR ROBUSTNESS AND SAFETY

The true value of the HW A-Series lies in its durability and high productivity. The robust upper and lower frame structure can endure external shock and heavy work loads. Attachment performance has been proven through rigorous field testing. No matter how tough the working environment is, you can always rely on the HYUNDAI Excavator HW A-Series.

Tougher from the ground up

Reinforced durability ▶

Built for unbeatable strength and sturdiness, the HW A-Series offers solid performance over its lifespan. The upper and lower frame structures are reinforced for tough working conditions, while the attachments have been rigorously tested for the roughest conditions.

Reinforced pins, bushings and polymer shims

The HW A series improves lubricity of connecting parts between the equipment and attachments. Gaps with attachments are minimized by wear-resistant long-life pins, bushings, and polymer shims, supporting the highest performance with invariable durability.

Better weight balance

The machine upper frame has been moved forward from the swing center to reduce the tail swing radius and the swing support height has been lowered to optimize weight balance.

Durable cooling module

Tested to extremes, the HW A Series has a durable cooling module proven to perform at maximum productivity levels in the toughest working environments.



The machine has been designed for high stability, easy handling and excellent manoeuvrability.

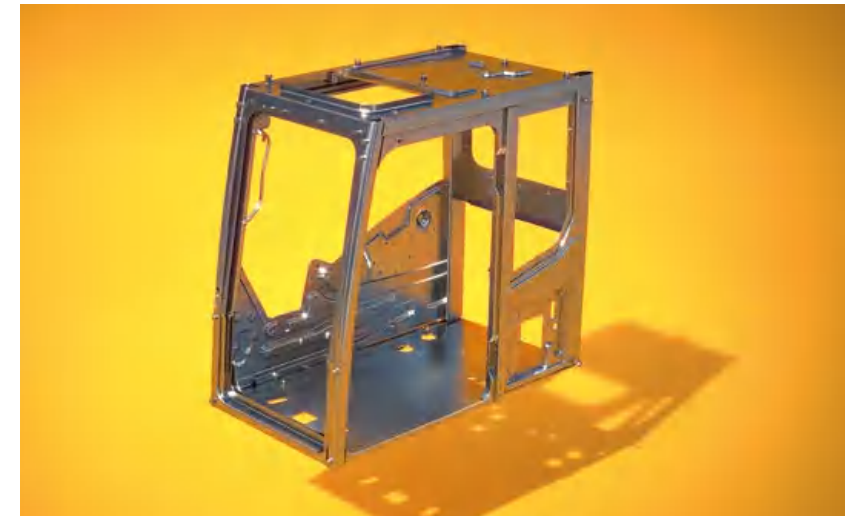

Cabin structure

The HW A-Series cabin structure uses integrally welded low-stress, high strength steel to meet ROPS and FOG certification.

- **ROPS:** Roll-Over Protective Structure ISO12117-2
- **FOPS:** Falling Object Protective Structure
- **FOG:** Falling Object Guard Level 2 (Option) ISO10262

Hi-grade (high-pressure) hoses ▶

The HW A-Series uses high-pressure hoses with improved heat and pressure resistance, greatly increasing the durability of the equipment.



The 4-wheel hydrostatic drive system ensures a smooth driving experience, even in rough conditions.

EASY CONTROL AND COMFORTABLE OPERATION

Many electronic functions are concentrated in the most convenient spot for operators to improve work efficiency. The highly-advanced infotainment system, a product of Hyundai's intensive information technology development, enables both productivity and comfort while working. The HW A-Series really is designed with the operator in mind.

Ergonomic for efficient operation

Intelligent & wide cluster ▶

The 8" capacitive-type display is similar to a smartphone to deliver excellent legibility. Amongst the key functions the centralised switches on the display allow convenient checking of the Adblue/DEF level and temperature outside the cabin.



Auxiliary joystick and pedal control ▶

A 2-way proportional auxiliary joystick and pedal control enable effortless operation to minimise operator fatigue.



Proportional auxiliary hydraulic system ▶

A proportional control switch with better speed control provides operators with added convenience whenever they do time-consuming work. This function can also be switched to control by foot pedal, by changing the setting in the cluster menu.



Jog Dial Module ▶

The accelerator, remote air conditioner controller and instrument cluster can be operated using the convenient jog shuttle-type controller.



Functionality at your fingertips

Joystick steering

The HW A-Series features right-hand joystick steering for quick, easy manoeuvring and enhanced productivity.

Work mode memory

The operator can select from three different work modes – Park, Work and Travel – for convenient automatic control of a range of functions

FNR and ram lock switch

The Forward/Reverse switch is positioned right at the operator's fingertip. The front axle oscillation lock can also be activated from the joystick, improving convenience and productivity on demanding jobs.

Fine swing & swing lock system

This option enables smooth movement at the start and stop of swing operation (cushion swing). The swing lock function provides additional safety, during road travel or transportation.

The HW A-Series is designed with the operator in mind. Many electronic functions are concentrated in the most convenient spot for operators to improve work efficiency.



A deluxe seat and full climate control provide a comfortable working environment for the operator.

13%
INCREASE IN CABIN SPACE

THE ULTIMATE SAFE ENVIRONMENT

The Hyundai approach to safety goes far beyond just meeting regulatory standards. We prioritise safety in every aspect of our machines and work with our customers to keep improving protection for operators, co-workers, passers-by, surrounding buildings and of course the machines themselves.

The short swing radius gives operators extra peace of mind and improves safety for colleagues and passers-by: while working on one lane of a road, the machine can swing without disturbing traffic on the second lane.



Visibly safer

AAVM (Advanced Around View Monitoring) camera system

The HX A-Series has a state-of-the-art AAVM video camera system to give an unobscured 360 degree field of vision for operators.

- **IMOD** (Intelligent Moving Object Detection): Informs when people or dangerous objects are detected within the range of operation (recognition distance: 5m).

Secure field of vision in all directions through ten views including 3D bird's eye view and 2D/4CH view.

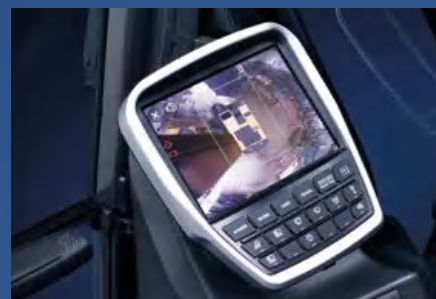

Built for safer operation

Cabin viscous mount

A coil spring and damper inside the cabin viscous mounts improve durability and provide a comfortable operating environment that lessens fatigue.

Emergency steering

If the hydraulic supply should fail, manual steering is automatically enabled.

Side camera

In addition to the standard rear view camera, there is an optional right hand side camera for giving the operator improved visibility.

Seat belt warning alarm

If the seat belt is not buckled when the ignition key is turned, an alarm is triggered in intervals along with a continuous visual alert. This emphasises our priority for operator safety

Electronic swing brake

An electronic valve and control system has been added to improve safety and utilisation. The opening and closing time of the swing brake valve is controlled according to the sensing and control system.

Cruise control & speed limiter

Cruise control and speed limiter allows the operator to regulate speed whilst in transit. An automatic creep speed enables the operator to concentrate on finer machine control and operation.

Axles and fenders

The HW A-Series has been equipped with a heavy duty axle for higher durability and to enhance stability in different conditions and material handling applications. Sturdy fenders, covering the wheel even when steering, have been added to protect the tyres from flying debris while driving.



Activate Auto Safety Check

The Auto Safety Lock prevents unintended operation due to the excavator not being controlled solely by the RCV lever.

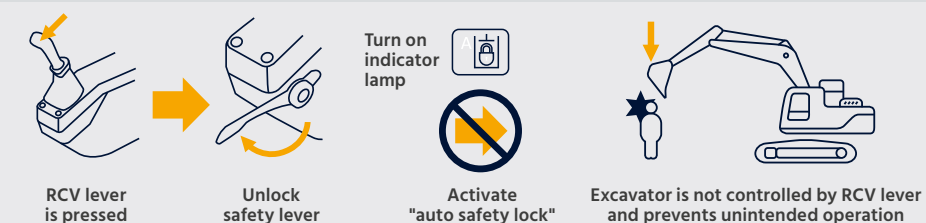

SERVICEABILITY AND TELEMATICS

Our A-Series excavators are designed with quick, low-effort servicing in mind. Every component and material has been optimised to ensure a long, trouble-free life. Hyundai's innovative Hi MATE telematics system enables full monitoring of machine activity and performance. Maximum connectivity is integrated to help owners create a smart construction site and protect profitability as their business grows.

Less maintenance. More uptime

Improved routine maintenance

Easy access for maintenance means regular checks get done faster, giving you more uptime and reducing operating costs. Ground level access to filters, lube fittings and master switches make servicing more convenient.

Longer maintenance intervals

The service interval of the fuel filter on the new engine has been increased by 100% (from 500h to 1000h). In addition the long life hydraulic oil (5000h change interval) contributes greatly to reduce the maintenance cost.

100%
IMPROVEMENT IN SERVICE INTERVAL



Hi MATE

It's convenient, easy and valuable. Hi MATE, Hyundai's remote management system, utilises GPS-satellite technology to provide customers with the highest level of service and product support available.

Increase productivity

By providing information such as service hours, idle time and fuel consumption, Hi MATE saves you money and improves productivity. Service alerts enable better maintenance planning.

ECD

(Engine Connected Diagnostics)

ECD provides troubleshooting information as well as tailored servicing. Service technicians are supported with remote diagnostics allowing them to achieve quick resolution rate

Monitor your machines

Hi MATE's real-time location information allows convenient monitoring of your equipment via the Hi MATE website or mobile app.

Mobile fleet app

Our Mobile Fleet app provides all the information you need to run your fleet efficiently and economically.

Improve Security

Protect your equipment from theft or unauthorised usage. Hi MATE's geofencing alerts notify you automatically when a machine leaves a predetermined zone.



HCE-DT Air allows service technicians to connect to your equipment wirelessly via smartphone and laptop right on site.

Keeping you covered

Hyundai genuine parts and accessories are designed to keep your machine running at optimum performance, providing increased uptime, comfort and productivity. Our 13000m² European Parts Warehouse guarantees 24-hour delivery across our dealer network.

Hyundai Standard and Extended Warranty Programmes are also available, providing peace of mind and giving you full control over your operating costs.



TAKE THE TOUR!

A

SERIES HW150A_{CR} HW170A_{CR}



Productivity & Efficiency

- High-performing Stage V engine with advanced exhaust aftertreatment **NEW**
- Load sensing hydraulic system **NEW**
- Variable Power Control **NEW**
- Hydrostatic 4-wheel drive
- Eco gauge
- Trailer hitch preparation **NEW** **OPTION**
- Electronically controlled reversible fan **NEW**
- Tiltrotator **NEW** **OPTION**
- 2D and 3D grading-ready **NEW** **OPTION**
- Floating boom position **OPTION**

Comfort

- 3-way adjustable steering column **NEW**
- Largest touchscreen monitor on the market (incl. WiFi)
- Attachment flow control
- Joystick steering **OPTION**
- FNR and Ram Lock Switch on Joystick **NEW**
- Ride control **NEW** **OPTION**
- Cruise control & speed limiter
- Advanced audio system
- Full climate control

Durability

- Reinforced upper and lower frame structure
- Reinforced pins, bushings and polymer shims
- Durable cooling module
- Hi-grade (high-pressure) hoses
- Centralised greasing system **OPTION**

Serviceability & Connectivity

- ECD (Engine Connected Diagnostics) **NEW**
- Improved DEF/AdBlue filler access
- Fuel filler pump with auto stop **OPTION**
- Hyundai Hi MATE telematics system
- Mobile Fleet app **OPTION**

Safety

- Advanced Around View Monitoring (AAVM) camera system **OPTION**
- LED working lights
- ROPS / FOPS certified cabin
- Safety glass
- Wide axle and fenders (HW170A CR only) **OPTION**
- Auto safety lock **NEW**
- Safety valves on all cylinders
- Automatic digging brake **NEW** **OPTION**

HW150A CR / HW170A CR SPECIFICATIONS

SPECIFICATIONS HW150A CR HW170A CR

ENGINE	
Maker / Model	CUMMINS / B4.5
Type	4 cylinder, water cooled, 4-cycle, turbocharged charge air cooled, direct injection, electronic controlled diesel engine.
Gross Power	129 kW (173 hp) at 2200 rpm
Net Power	127 kW (170 hp) at 2200 rpm
Max. Power	129 kW (173 hp) at 2200 rpm
Peak Torque	780 N·m at 1500 rpm
Displacement	4.5 l

HYDRAULIC SYSTEM

Advanced Load Sensing System (LUDV)
Load independent flow sharing

MAIN PUMP	
Type	Variable displacement pump
Max. flow	261 lpm @ 1800 rpm

AUX PUMP	
Type	Piston pump
Max. flow	60 lpm

* Load Sensing - Variable displacement pump : LUDV (load independent flow sharing)

HYDRAULIC MOTORS

Travel	Bent - axis piston motor with brake valve and parking brake
Swing	Radial Piston Motor

RELIEF VALVE SETTING

Implement circuits	350 kgf/cm ² (4970 psi)
Travel	380 kgf/cm ² (5400 psi)
Power boost (boom, arm, bucket)	380 kgf/cm ² (5400 psi)
Swing circuit	285 kgf/cm ² (4050 psi)
Pilot circuit	35 kgf/cm ² (500 psi)
Service valve	Installed

HYDRAULIC CYLINDERS

No. of cylinder bore x stroke	Arm:	
	1-115 x 1138 mm	1-120 x 1235 mm
	Bucket:	
	1-100 x 850 mm	1-105 x 995 mm
	Blade:	
	2-110 x 235 mm	2-110 x 235 mm
	Outrigger:	
	2-125 x 463 mm	2-125 x 463 mm
	Monoboom:	
	1-105 x 1,105mm	
	2-PCS boom:	
	2-105 x 992mm	2-110 x 992mm
	Adjust(boom):	
	1-145 x 634mm	1-160 x 624mm

* Hyundai Bio Hydraulic Oil (HBHO) available.

DRIVES & BRAKES

4-wheel hydrostatic drive. Constant mesh, helical gear transmission provides 2 forward and reverse travel speeds.

Max. drawbar pull	9234 kgf	10720 kgf
Travel speed	1st: 9.5 km/h	1st: 9.5 km/h
	2nd: 35 km/h or 20 km/h (Option)	2nd: 35 km/h or 20 km/h (Option)
Gradeability	30°(70 %)	35°(70 %)

Service Brake :
- Independent dual brake, front and rear axle full hydraulic power brake.
- Spring released and hydraulic applied wet type multiple disc brake.
Parking Brake :
- Spring applied and hydraulic released wet disc brake type in transmission.

CONTROLS

Pilot control	Two joysticks with one safety lever (LH): Swing and arm, (RH): Boom and bucket (ISO) FNR switch on RH joystick / Ram lock switch on LH joystick
Attachment Control	3 modes available: Push / Proportional / Permanent
Engine throttle	Electric, Dial type
Operation Mode	3 modes available: P-Parking W-Working T-Travel

SPECIFICATIONS HW150A CR HW170A CR

AXLE & WHEELS

Full floating front axle is supported by center pin for oscillation. Oscillation lock (ram lock) function for safe operation. Rear axle is fixed on the lower chassis.

Tyres	10.00-20-14PR, Dual (tube type)
(Optional)	10.00-20, Dual (solid type) 10.00-20-16PR, Dual (tube type)

STEERING SYSTEM

Hydraulically actuated, orbitrol type steering system actuates on front wheels through steering cylinders.

Min. turning radius	6300 mm
---------------------	---------

SWING SYSTEM

Swing motor	Fixed displacement radial piston motor
Swing reduction	Planetary gear reduction
Swing bearing lubrication	Grease-bathed
Swing brake	Multi wet disc
Swing speed	9.3 rpm

COOLANT & LUBRICANT CAPACITY

	liter
Fuel tank	200
Engine coolant	19.5
Engine oil	11
Swing device - gear oil (OPT)	6.2 (5.0)
Swing device - grease (OPT)	(1.2)
Axle	Front: 15.5 Rear: 17.5
Transmission	2.5
Hydraulic system (including tank)	187
Hydraulic tank	103
DEF/AdBlue®	27

UNDERCARRIAGE

Reinforced box-section frame is all-welded, low-stress. Dozer blade and outriggers are available. A pin-on design.

Dozer blade: Parallelogram-mounted dozer blade to support machine when working, also for leveling and back filling.

Outrigger: Indicated for max. operation stability when digging and lifting. Can be mounted on front/or rear.

OPERATING WEIGHT (APPROXIMATE)

HW150A CR: Operating weight, including 4710 mm 2pc boom, 2450 mm arm, SAE heaped 0.70 m³ bucket, lubricant, coolant, full fuel tank, hydraulic tank and standard equipment.

HW170A CR: Operating weight, including 5000 mm 2pc boom, 2450 mm arm, SAE heaped 0.70 m³ bucket, lubricant, coolant, full fuel tank, hydraulic tank and standard equipment.

OPERATING WEIGHT

Rear dozer blade	17170 kg	18820 kg
Rear outriggers	17440 kg	19090 kg
Front outriggers and rear blade	18390 kg	20040 kg
Front blade and rear outriggers	18390 kg	20040 kg
Four outriggers	18660 kg	20310 kg

AIR CONDITIONING SYSTEM

The air conditioning system contains fluorinated greenhouse gas refrigerant R134a (Global Warming Potential = 1430). The system contains 0.75 kg of refrigerant representing a CO₂ equivalent of 1.07 metric tonnes.

HW150A CR DIMENSIONS & WORKING RANGE

HW150A CR MONO BOOM DIMENSIONS

4.6m Mono boom, 2.0m, 2.45m, 2.6m Arm, Rear dozer

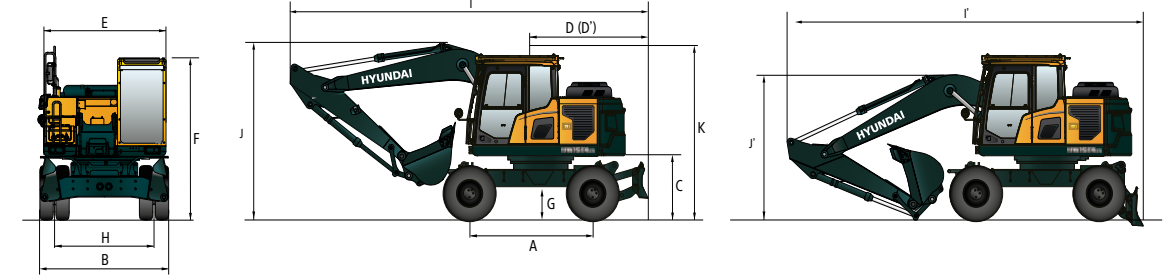

A	Wheel base	2600
B	Overall width	2530
C	Ground clearance of counterweight	1265
D	Rear-end distance	1790
D'	Rear-end swing radius	1800
E	Upperstructure width	2500
F	Overall height of cab	3230
G	Min. ground clearance	370
H	Tread	1944
K	Overall height of guardrail	3450

		Unit : mm		
Boom length		4600		
Arm length		2000	2450	2600
I	Overall length (Traveling position)	7885	7710	7610
I'	Overall length (Shipping position)	7780	7630	7845
J	Overall height of boom (Traveling position)	3270	3790	3930
J'	Overall height of boom (Shipping position)	2820	2990	3110

HW150A CR MONO BOOM WORKING RANGE

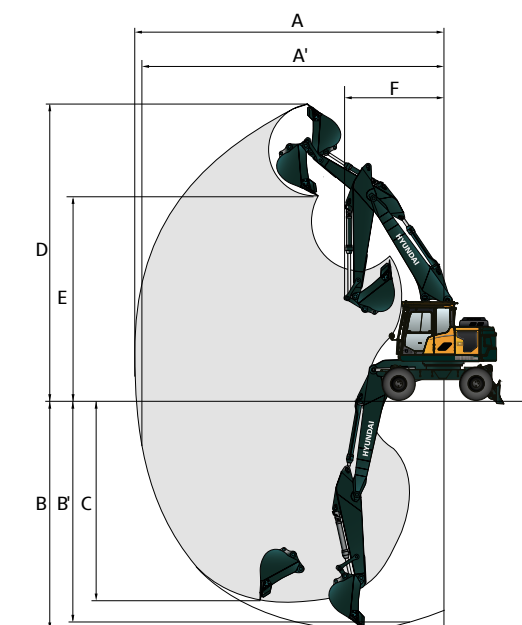

		Unit : mm		
Boom Length		4600		
Arm Length		2000	2450	2600
A	Max. Digging Reach	7940	8370	8520
A'	Max. Digging Reach on Ground	7710	8150	8300
B	Max. Digging Depth	4680	5130	5280
B'	Max. Digging Depth (8° Level)	4425	4920	5070
C	Max. Vertical Wall Digging Depth	4220	4675	4820
D	Max. Digging Height	8520	8830	8920
E	Max. Dumping Height	6080	6380	6470
F	Min. Swing Radius	2650	2740	2755

HW150A CR DIMENSIONS & WORKING RANGE

HW150A CR 2-PIECE BOOM DIMENSIONS

4.71m 2-Piece boom, 2.0m, 2.45m, 2.6m Arm, Rear dozer

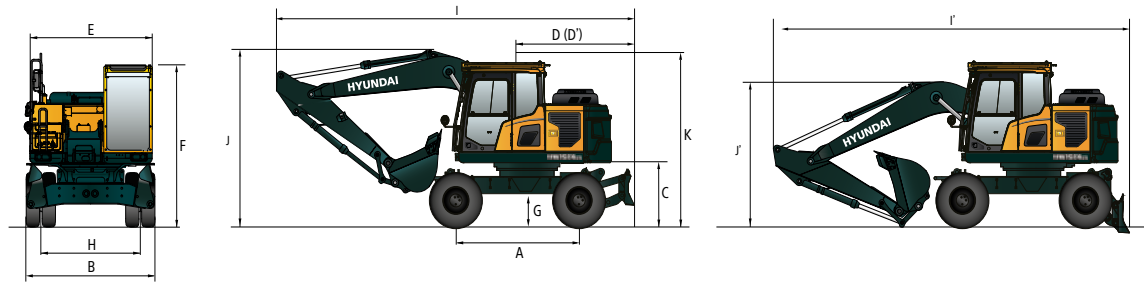

Unit : mm

A	Wheel base	2600
B	Overall width	2530
C	Ground clearance of counterweight	1265
D	Rear-end distance	1790
D'	Rear-end swing radius	1800
E	Upperstructure width	2500
F	Overall height of cab	3230
G	Min. ground clearance	370
H	Tread	1944
L	Overall height of guardrail	3450

Boom length		4710		
Arm length		2000	2450	2600
I	Overall length (Traveling position)	5980	5940	5920
I'	Overall length (Shipping position)	7940	7945	7950
J	Overall height of boom (Traveling position)	3980	3970	3980
J'	Overall height of boom (Shipping position)	2940	2990	3040
K	End of attachment to steering wheel	2820	2990	3110

HW170A CR DIMENSIONS & WORKING RANGE

HW170A CR 2-PIECE BOOM DIMENSIONS

5.0 m 2-Piece boom, 2.0 m, 2.45 m, 2.6 m Arm, Rear dozer

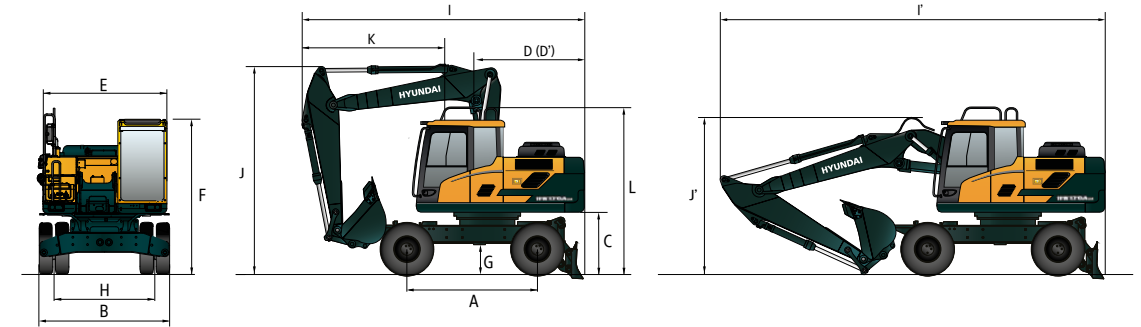

Unit : mm

A	Wheel base	2600
B	Overall width (STD / Wide axle)	2530 / 2700
C	Ground clearance of counterweight	1265
D	Rear-end distance	1830
D'	Rear-end swing radius	1830
E	Upperstructure width	2500
F	Overall height of cab	3220
G	Min. ground clearance	340
H	Tread	1944
L	Overall height of guardrail	3275

Boom length		5000		
Arm length		2000	2450	2600
I	Overall length (Traveling position)	5880	5850	5790
I'	Overall length (Shipping position)	7900	7860	7820
J	Overall height of boom (Traveling position)	3940	3940	3960
J'	Overall height of boom (Shipping position)	2940	2900	3150
k	End of attachment to steering wheel	3050	3030	2960

HW150A CR 2-PIECE BOOM WORKING RANGE

Unit : mm

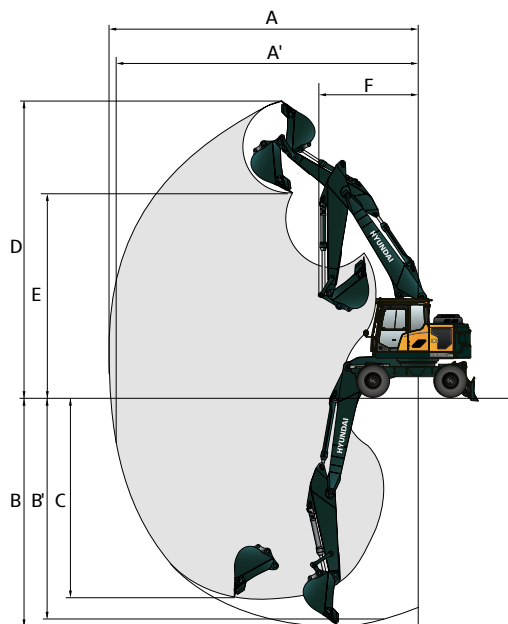

Boom Length		4710		
Arm Length		2000	2450	2600
A	Max. Digging Reach	8110	8550	8700
A'	Max. Digging Reach on Ground	7890	8340	8490
B	Max. Digging Depth	4570	5020	5170
B'	Max. Digging Depth (8° Level)	4450	4910	5060
C	Max. Vertical Wall Digging Depth	3950	4430	4575
D	Max. Digging Height	9110	9460	9580
E	Max. Dumping Height	6630	6970	7090
F	Min. Swing Radius	2660	2670	2710

HW170A CR 2-PIECE BOOM DIMENSIONS

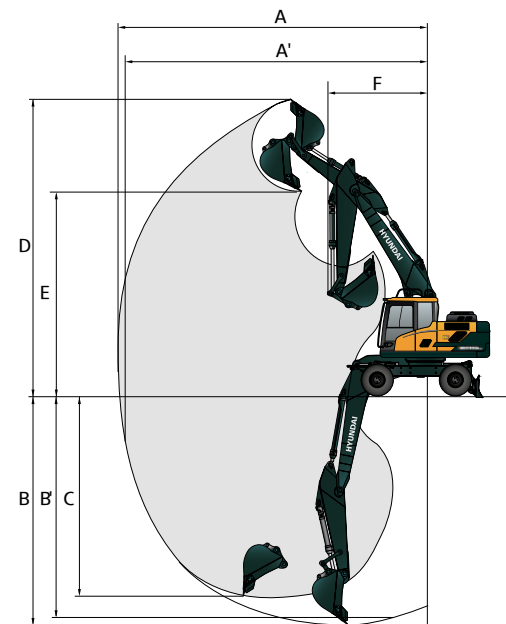

Unit : mm



Boom Length		5000		
Arm Length		2000	2450	2600
A	Max. Digging Reach	8490	8950	9020
A'	Max. Digging Reach on Ground	8280	8750	8820
B	Max. Digging Depth	4980	5440	5565
B'	Max. Digging Depth (8° Level)	4870	5340	5460
C	Max. Vertical Wall Digging Depth	4150	4680	4680
D	Max. Digging Height	9370	9785	9680
E	Max. Dumping Height	6660	7060	6980
F	Min. Swing Radius	3380	3040	3500

HW150A CR











LIFTING CAPACITY

 Rating over-front  Rating over-side or 360 degrees











 Rating over-front  Rating over-side or 360 degrees

HW150A CR MONO BOOM











4.6 m Mono boom, 2.00 m arm equipped with 3250 kg counter weight, dozer down.

Lift-point height m	kg	Lift-point radius								At max. Reach		
		1.5 m		3.0 m		4.5 m		6.0 m		Capacity	Reach	
												m
6.0 m	kg					*4420	4350			*3340	*3340	5.19
4.5 m	kg					*4810	4240	*3870	2710	*3120	2610	6.13
3.0 m	kg					*5800	4020	4190	2640	*3150	2290	6.59
1.5 m	kg					6280	3800	4090	2550	*3380	2190	6.68
0.0 m	kg			*6020	*6020	6150	3680	4030	2500	3670	2290	6.42
-1.5 m	kg	*6310	*6310	*9650	6750	6150	3680			4310	2670	5.74
-3.0 m	kg			*7160	6940					*4610	3860	4.46

4.6 m Mono boom, 2.45 m arm equipped with 3250 kg counter weight, dozer down.

Lift-point height m	kg	Lift-point radius								At max. Reach		
		3.0 m		4.5 m		6.0 m		7.5 m		Capacity	Reach	
												m
7.5 m	kg									*2900	*2900	4.19
6.0 m	kg									*2400	*2400	5.74
4.5 m	kg					*4340	4300	*3870	2740	*2250	*2250	6.60
3.0 m	kg			*8000	7500	*5370	4060	4200	2650	*2260	2060	7.03
1.5 m	kg			*5100	*5100	6300	3810	4080	2540	*2410	1980	7.12
0.0 m	kg			*6320	*6320	6130	3660	4000	2470	*2730	2050	6.87
-1.5 m	kg	*5450	*5450	*10200	6650	6090	3620	3990	2460	*3420	2340	6.24
-3.0 m	kg			*8180	6800	*5500	3700			*4460	3140	5.10









4.6 m Mono boom, 2.60 m arm equipped with 3250 kg counter weight, dozer down.

Lift-point height m	kg	Lift-point radius								At max. Reach		
		3.0 m		4.5 m		6.0 m		7.5 m		Capacity	Reach	
												m
7.5 m	kg									*2670	*2670	4.43
6.0 m	kg									*2230	*2230	5.92
4.5 m	kg					*4190	*4190	*3770	2750	*2100	*2100	6.76
3.0 m	kg			*7640	7570	*5230	4080	4210	2660	*2120	2000	7.18
1.5 m	kg			*5810	*5810	6310	3820	4080	2540	*2250	1920	7.26
0.0 m	kg			*6390	*6390	6130	3650	3990	2460	*2540	1990	7.01
-1.5 m	kg	*5220	*5220	*10050	6610	6070	3610	3970	2440	*3130	2250	6.40
-3.0 m	kg	*9280	*9280	*8470	6750	*5700	3670			*4400	2960	5.30











- Lifting capacities are based on ISO 10567.
- Lifting capacity of the HW A-series does not exceed 75% of tipping load with the machine on firm, level ground or 87% of full hydraulic capacity.
- The Lift-point is bucket pivot mounting pin on the arm (without bucket mass).
- (*) indicates load limited by hydraulic capacity.
- Caution: please be aware of the local regulations and instructions for lifting operations.

HW150A CR 2-PIECE BOOM









4.71 m 2-Piece boom, 2.00 m arm equipped with 3250 kg counter weight, dozer down.

Lift-point height m	kg	Lift-point radius						At max. Reach		
		3.0 m		4.5 m		6.0 m		Capacity	Reach	
										m
7.5 m	kg							*4440	*4440	3.71
6.0 m	kg			*4210	*4210			*3480	3200	5.41
4.5 m	kg	*5850	*5850	*4650	4240	*4240	2710	*3210	2470	6.32
3.0 m	kg			*5640	3990	4190	2630	*3180	2180	6.77
1.5 m	kg			6270	3760	4080	2530	*3350	2090	6.86
0.0 m	kg			6140	3640	4020	2470	3530	2190	6.60
-1.5 m	kg	*9690	6710	6140	3640			4110	2530	5.94

4.71 m 2-Piece boom, 2.45 m arm equipped with 3250 kg counter weight, dozer down.

Lift-point height m	kg	Lift-point radius								At max. Reach		
		1.5 m		3.0 m		4.5 m		7.5m		Capacity	Reach	
												m
7.5 m	kg									*3050	*3050	4.49
6.0 m	kg			*3710	*3710					*2510	*2510	5.97
4.5 m	kg			*4210	*4210	*3880	2730			*2330	2210	6.80
3.0 m	kg			*5230	4040	4200	2630			*2310	1970	7.21
1.5 m	kg			6290	3770	4080	2520			*2410	1890	7.30
0.0 m	kg	*4890	*4890	6120	3620	3990	2440			*2670	1960	7.05
-1.5 m	kg	*8930	6600	6080	3590	3980	2430			*3210	2230	6.45
-3.0 m	kg											

4.71 m 2-Piece boom, 2.60 m arm equipped with 3250 kg counter weight, dozer down.

Lift-point height m	kg	Lift-point radius						At max. Reach			
		3.0 m		4.5 m		6.0 m		Capacity	Reach		
										m	
7.5 m	kg			*3420	*3420			*2810	*2810	4.73	
6.0 m	kg			*3560	*3560	*2880	2760	*2330	*2330	6.15	
4.5 m	kg			*4060	*4060	*3780	2750	*2170	2130	6.95	
3.0 m	kg	*7590	7510	*5090	4060	*4180	2640	*2160	1910	7.36	
1.5 m	kg			*6200	3780	4080	2520	*2250	1840	7.44	
0.0 m	kg	*4980	*4980	6110	3610	3990	2430	*2480	1900	7.20	
-1.5 m	kg	*8600	6560	6060	3570	3960	2420	*2960	2140	6.61	
-3.0 m	kg			*5860	3640						

- Lifting capacities are based on ISO 10567.
- Lifting capacity of the HW A-series does not exceed 75% of tipping load with the machine on firm, level ground or 87% of full hydraulic capacity.
- The Lift-point is bucket pivot mounting pin on the arm (without bucket mass).
- (*) indicates load limited by hydraulic capacity.
- Caution: please be aware of the local regulations and instructions for lifting operations.

HW170A CR LIFTING CAPACITY

Rating over-front Rating over-side or 360 degrees

HW170A CR 2-PIECE BOOM

5.0 m 2-Piece boom, 2.00 m arm equipped with 4200 kg counterweight, dozer blade down

Lift-point height m		Lift-point radius						At max. Reach		
		3.0 m		4.5 m		6.0 m		Capacity		Reach
										m
7.5 m	kg							*4790	*4790	4.19
6.0 m	kg			*4310	*4310			*4390	3240	5.75
4.5 m	kg			*4930	4680	*4350	3000	4000	2550	6.60
3.0 m	kg			*6070	4350	4560	2880	3570	2250	7.03
1.5 m	kg			6770	4070	4430	2750	3450	2160	7.12
0.0 m	kg			6630	3940	4340	2680	3600	2240	6.87
-1.5 m	kg	*9480	7320	6630	3950	4360	2690	4140	2570	6.24

5.0 m 2-Piece boom, 2.45 m arm equipped with 4200 kg counterweight, dozer blade down

Lift-point height m		Lift-point radius								At max. Reach		
		3.0 m		4.5 m		6.0 m		7.5 m		Capacity		Reach
												m
7.5 m	kg			*4020	*4020					*2760	*2760	4.95
6.0 m	kg			*3820	*3820	*3550	3070			*2330	*2330	6.31
4.5 m	kg			*4470	*4470	*4010	3020			*2180	*2180	7.10
3.0 m	kg			*5630	4410	*4480	2880	*2180	2020	*2160	2020	7.50
1.5 m	kg			*6770	4080	4420	2740	*2940	1980	*2260	1940	7.58
0.0 m	kg			6600	3910	4310	2640			*2490	2010	7.35
-1.5 m	kg	*8350	7170	6560	3880	4280	2620			*2960	2250	6.77
-3.0 m	kg			*6380	3970							

5.0 m 2-Piece boom, 2.6 m arm equipped with 4200 kg counterweight, dozer blade down

Lift-point height m		Lift-point radius								At max. Reach		
		3.0 m		4.5 m		6.0 m		7.5 m		Capacity		Reach
												m
7.5 m	kg			*3810	*3810					*2920	*2920	5.15
6.0 m	kg			*3660	*3660	*3740	3090			*2510	*2510	6.47
4.5 m	kg			*4310	*4310	*3900	3030			*2360	2190	7.24
3.0 m	kg			*5480	4430	*4390	2890	*3130	2020	*2360	1960	7.63
1.5 m	kg			*6660	4090	4420	2740	3170	1970	*2470	1890	7.71
0.0 m	kg			6590	3900	4300	2630			*2730	1940	7.48
-1.5 m	kg	*8140	7130	6540	3850	4270	2600			*3240	2170	6.91
-3.0 m	kg			*6510	3930							

- Lifting capacities are based on ISO 10567.
- Lifting capacity of the HW A-series does not exceed 75% of tipping load with the machine on firm, level ground or 87% of full hydraulic capacity.
- The Lift-point is bucket pivot mounting pin on the arm (without bucket mass).
- (*) indicates load limited by hydraulic capacity.
- Caution: please be aware of the local regulations and instructions for lifting operations.

HW150A CR / HW170A CR BUCKET SELECTION GUIDE & DIGGING FORCE

HW150A CR BUCKETS

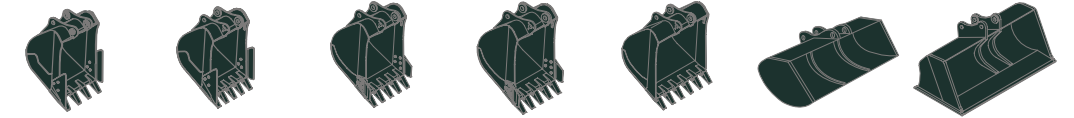

SAE heaped m³	◆ 0.50	◆ 0.61	0.52	0.65	0.71	■ 0.45	● 0.55
				0.58			

Capacity m³	Width mm	Weight kg	Tooth EA	Recommendation mm							
				4200 kg CWT							
				4600 Mono Boom			4710 (2PCS) Mono Boom				
SAE heaped	CECE heaped	Without side cutters	With side cutters								
0.58	0.50	950	1,100	480	5	●	○	○	●	○	■
0.52	0.45	870	1,020	460	5	●	●	●	●	●	○
0.65	0.55	1,060	1,210	513	5	○	■	■	○	■	■
0.71	0.60	1,140	1,300	536	5	○	■	■	■	▲	▲
■ 0.45	0.40	1,520	1,520	410	0	●	●	●	●	●	●
● 0.55	0.45	1,800	1,800	585	0	●	○	○	●	○	■
◆ 0.50	0.45	762	821	439	4	●	●	●	●	●	●
◆ 0.61	0.54	914	974	490	5	●	○	○	○	■	■

- ◆ General Purpose
- Heavy Duty
- Rock-HD
- Applicable for materials with density of 2100 kg/m³ or less
- Applicable for materials with density of 1800 kg/m³ or less
- Applicable for materials with density of 1500 kg/m³ or less
- ▲ Applicable for materials with density of 1200 kg/m³ or less
- X Not Recommended

HW170A CR BUCKETS

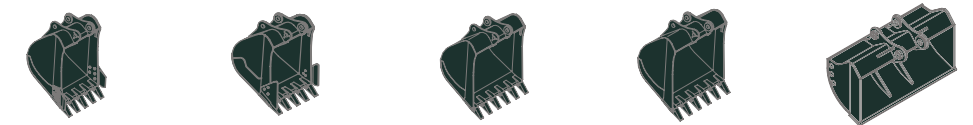

SAE heaped m³	0.70	◆ 0.73	0.89	■ 0.69	● 0.75
		0.76	◆ 0.85	1.05	

Capacity m³	Width mm	Weight kg	Tooth EA	Recommendation mm				
				4200 kg CWT				
				4990 2-Piece Boom				
SAE heaped	CECE heaped	Without side cutters	With side cutters					
0.70	0.60	1020	1100	600	5	○	■	■
0.76	0.65	1090	1170	620	5	■	▲	▲
0.89	0.77	1250	1325	680	6	▲	▲	X
1.05	0.90	1430	1510	740	6	X	X	X
■ 0.69	0.62	1050	-	720	5	○	■	▲
● 0.75	0.65	1760	-	540	0	○	■	■
◆ 0.73	0.67	914	946	620	5	○	■	▲
◆ 0.85	0.76	1067	1096	670	5	■	▲	▲

- ◆ General Purpose
- Heavy Duty
- Rock-HD
- Applicable for materials with density of 2100 kg/m³ or less
- Applicable for materials with density of 1800 kg/m³ or less
- Applicable for materials with density of 1500 kg/m³ or less
- ▲ Applicable for materials with density of 1200 kg/m³ or less
- X Not Recommended

HW150A CR / HW170A CR

BUCKET SELECTION GUIDE & DIGGING FORCE

ATTACHMENT

Booms and arms are welded with a low-stress full-box section design. 2.0 m 2.45 m 2.6 m arms are available.

HW150A CR DIGGING FORCE						
Boom	Length	mm	4600 Mono			Remark
Arm	Length	mm	2000	2450	2600	
Bucket digging force	SAE	kN	87.8 [107]	87.9 [95.4]	87.9 [95.4]	[] : Power Boost
		kgf	8956.9 [9720]	8960.9 [9730]	8960.9 [9730]	
	ISO	kN	102.9 [111.7]	102.9 [111.7]	102.9 [111.7]	
		kgf	10489.4 [11390]	10494 [11390]	10494 [11390]	
Arm crowd force	SAE	kN	74.2 [80.6]	63.6 [69.0]	61.1 [66.3]	
		kgf	7569.4 [8220]	6485.2 [7040]	6230.3 [6760]	
	ISO	kN	77.9 [84.5]	66.3 [72.0]	63.6 [69.0]	
		kgf	7942 [8620]	6763.7 [7340]	6485.9 [7040]	

Boom	Length	mm	4710 2-Piece			Remark
Arm	Length	mm	2000	2450	2600	
Bucket digging force	SAE	kN	87.8 [95.3]	87.9 [95.4]	87.9 [95.4]	[] : Power Boost
		kgf	8,956.9 [9720]	8,960.9 [9730]	8,960.9 [9730]	
	ISO	kN	102.9 [111.7]	102.9 [111.7]	102.9 [111.7]	
		kgf	10,489.4 [11390]	10,494 [11390]	10,494 [11390]	
Arm crowd force	SAE	kN	74.2 [80.6]	63.6 [69.0]	61.1 [66.3]	
		kgf	7,569.4 [8220]	6,485.2 [7040]	6,230.3 [6760]	
	ISO	kN	77.9 [84.5]	66.3 [72.0]	63.6 [69.0]	
		kgf	7,942 [8620]	6,763.7 [7340]	6,485.9 [7040]	

HW170A CR DIGGING FORCE						
Boom	Length	mm	5100			Remark
Arm	Length	mm	2000	2450	2600	
Bucket digging force	SAE	kN	98 [107]	98 [107]	98 [107]	[] : Power Boost
		kgf	10008 [10920]	9992 [10900]	10026 [10940]	
	ISO	kN	115 [125]	115 [125]	115 [126]	
		kgf	11726 [12790]	11706 [12770]	11746 [12810]	
Arm crowd force	SAE	kN	85 [93]	67 [73]	67 [73]	
		kgf	8648 [9430]	6858 [7480]	6798 [7420]	
	ISO	kN	89 [98]	70 [77]	70 [76]	
		kgf	9118 [9950]	7178 [7830]	7106 [7750]	

STANDARD/OPTIONAL EQUIPMENT

ENGINE	STD
Cummins B 4.5 engine	•

HYDRAULIC SYSTEM	STD
Advanced Load Sensing (LUDV)	
3-power modes, 3-work modes, user mode	•
Power Boost Function	•
Attachment Flow Control	•
3 attachment control modes (Push/Prop./Permanent)	•
Engine Auto Idling	•
Engine Auto Shutdown	•
Electronic Fan Control (reversible)	•
35 km/h or 20 km/h travel motor	
Hyundai Bio Hydraulic Oil (HBHO)	

CABIN & INTERIOR	STD
ISO Standard cabin	
All-weather steel cab with 360°visibility	•
Parallel type windshield wiper	•
Radio / USB / MP3 player	•
Handsfree mobile phone system with USB	•
12 volt power outlet (24V DC to 12V DC converter)	•
Electric horn	•
Safety glass - Tempered glass with front laminated glass	•
Safety glass windows	•
Sliding fold-in front window	•
Sliding side window (LH)	•
Lockable door	•
Hot & cool box	•
Storage compartment	•
Transparent cabin roof-cover	•
Sun visor	•
Door and cabin locks, one key	•
Smart key & Start button	•
Pilot-operated proportional joysticks	•
Steering wheel with 3-way adjustable steering column	•
Cabin front window rain guard	•
Automatic climate control	
Air conditioner & heater	•
Defroster	•
Starting Aid (air grid heater) for cold weather	•
Centralised monitoring	
8" LCD touchscreen display	•
Engine speed or Trip meter/Accel.	•
Engine coolant temperature gauge	•
Max power	•
Low speed/High speed	•
Auto idle	•
Overload warning with alarm	•
Check Engine	•
Air cleaner clogging	•
Indicators	•
ECO Gauge	•
Fuel level gauge	•
Hyd. oil temperature gauge	•
Warnings	•
Communication error	•
Low battery	•
Clock	•
Seat	
Adjustable air suspension seat with heater	•
Mechanical suspension seat with heater	
Cabin ROPS (ISO 12117-2)	
ROPS (Roll Over Protective Structure)	•
Cabin FOPS/FOG (ISO 10262) Level 2	
FOPS (Falling Object Protective Structure)	•
FOG (Falling Object Guard)	Front & Top Guard Top Guard

SAFETY	STD
Safety lock valve on boom cylinders with overload warning device	•
Safety lock valve on arm cylinder	•
Safety lock valve on dozer blade and ram lock cylinders	•
Four outside rearview mirrors	•
Rearview camera	•
Rear & Mirror view camera	
AAVM (Advanced Around View Monitoring)	
Four front working lights LED (2 boom mounted, 2 front frame mounted)	•
Rear work lamp LED	•
Beacon lamp LED	
Travel alarm	•
Automatic swing brake	•
Swing Lock System	
Auto-digging brake	
Joystick Steering	
Battery master switch	•
Wheel chock	•

ATTACHMENT	STD
HW150A CR Boom options	
4.6 m, Mono	•
4.71 m, 2-Piece	
HW170A CR Boom options	
5.0 m, 2-Piece	•
Arm options	
2.00 m	
2.45 m	•
2.60 m	

OTHER	STD
Ride control (boom suspension system)	
Boom floating system	
Cruise control	•
Speed Limiter	•
Creep speed travel mode	•
Heavy counterweight	•
Removable clean-out dust net for cooler	•
Fuel pre-filter	•
Self-diagnostics system	•
Hi MATE (Remote Management System)	Mobile Satellite
Batteries (2 x 12V x 100 AH)	•
Fuel filler pump (35 lpm) with autopost	•
Single-acting piping kit (breaker, etc.)	•
Double-acting piping kit (clamshell, etc.)	•
Rotating piping kit	
Quick coupler piping	
Quick coupler	
Accumulator for lowering work equipment	•
Pattern change valve (2 patterns)	
Fine Swing Control System	
Tool kit	
Lower Frame Toolbox - LH	•
Lower Frame Toolbox - LH, RH	

UNDERCARRIAGE	STD
Rear dozer blade	•
Rear outriggers	
Front outriggers and rear blade	
Front and rear outriggers	
Front dozer blade	
Front blade and rear outriggers	
Front grapple rest and rear blade	
Front grapple rest and rear outriggers	
Trailer hitch preparation kit for rear dozer blade	
Tires-dual (10.00-20-14PR tube)	•
Tires-dual (10.00-20-16PR tube)	
Tires-dual (10.00-20 solid)	
Fenders (Mudguards)	•
General axle 2.5 m	•
Wide axle 2.7 m (HW170A CR Only)	•

* Standard and optional equipment may vary. Contact your Hyundai dealer for more information.
 * The machine may vary according to International standards.
 * The photos may include attachments and optional equipment that are not available in your area.
 * Materials and specifications are subject to change without advance notice.





HYUNDAI

Specifications and design are subject to change without notice. Pictures of Hyundai Construction Equipment Europe products may show other than standard equipment.

Hyundai Construction Equipment Europe nv,
Hyundailaan 4, 3980 Tessenderlo, Belgium.
Tel: (32) 14-56-2200 Fax: (32) 14-59-3405

READY TO CHANGE YOUR WORLD?

Contact your Hyundai dealer.
hyundai-ce.eu/en/dealer-locator