

**Gross Power**  
173kW (232hp) at 2,000rpm

**Net Power**  
169kW (227hp) at 2,000rpm

**Bucket Capacity**  
0.80 ~ 1.34m<sup>3</sup>

**Operating Weight**  
27,000kg / 59,520lb

# HX260AL

With EU Stage V Engine installed



## ▲ HYUNDAI CONSTRUCTION EQUIPMENT

**Head Office(Sales Office)**

3F, Bundang First Tower, 55 Bundang-ro, Bundang-gu, Seongnam-si, Gyeonggi-do, 13591, Korea

**Americas Operation : Hyundai Construction Equipment Americas, Inc.**

6100 Atlantic Boulevard Norcross Ga 30071 U.S.A  
TEL (1) 847-678-823-7802 FAX (1) 847-678-823-7778

**Europe Operation : Hyundai Construction Equipment Europe N.V.**

Hyundailaan 4,  
3980 Tessenderlo, Belgium  
TEL (32) 14-56-2200 FAX (32) 14-59-3405

PLEASE CONTACT





# WHAT'S NEWEST AND BEST

**HX260AL**

## THE BEST PRODUCTIVITY AND FUEL EFFICIENCY

- EU STAGE V Engine **NEW**
- Eco Report **NEW**
- EPFC System **NEW**
- Lifting Mode **NEW**
- Fuel Rate Information
- Eco Gauge
- Automatic Engine Shut Down

## ULTIMATE DURABILITY

- Side Protector **Option**
- ROPS / FOG Cabin
- Reinforced Durability of Upper and Lower Structure and Attachments
- Durable Cooling Module

## EASY CONTROL AND COMFORTABLE OPERATION

- Key On Initial Work Mode **NEW**
- Visibility and Handle Improvement **NEW**
- One Pedal Travel Straight **Option**
- Proportional Auxiliary Hydraulic System **Option** (RCV Switch & Pedal control selection)
- Fine(Cushion/Free) Swing Control **Option**
- Intelligent & Wide Cluster
- Jog Dial Module
- OME(Owner Menu Editing)
- Combination Speed



## THE ULTIMATE SAFE ENVIRONMENT

- Auto Safety Lock **NEW**
- Electronic Swing Parking Brake **NEW**
- AAVM **Option**
- Seatbelt Warning Alarm

## SERVICEABILITY AND TELEMATICS

- ECD(Engine Connected Diagnostics) **NEW**
- Hi-MATE **Option**
- 2x Longer Lasting Fuel Filter (1,000hr)
- Urea Tank Cover **Upgrade**
- Mobile Fleet App.
- Connected Diagnostics





# THE BEST PRODUCTIVITY AND FUEL EFFICIENCY

HX A Series is equipped with eco-friendly, high-performance engines that meet the EU Stage V emission requirements.



## ENVIRONMENTALLY FRIENDLY FUEL EFFICIENCY

### Eco Report **NEW**

It reports the excavator's inefficient operation status and help improving operator's working habit.



### Fuel Rate Information

Fuel information is displayed as average rate and latest fuel consumed for guiding to economy operating.



### Eco Gauge

Gauge level changes in accordance with engine working load and color indicates fuel saving-operation status.

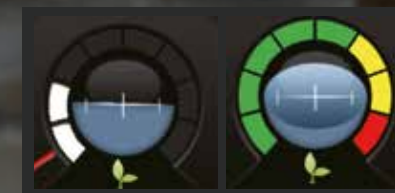

### Automatic Engine Shut Down

Adjustable 'Automatic engine shut down' significantly reduces idle time. Overall operating hours and fuel consumption.



## EU STAGE V CERTIFIED ENGINE

Cummins B6.7 engine is satisfying the most strict environmental emission regulation in the world. (Reduction in PM 60%)

### EU STAGE V Engine **NEW**

Now in its fourth decade of continuous improvement, the B6.7 for 2019 features an EGR-free design that delivers 5 percent more power and 31 percent more peak torque than the current model. Increased fuel economy and longer maintenance intervals contribute to a reduced cost of operation.

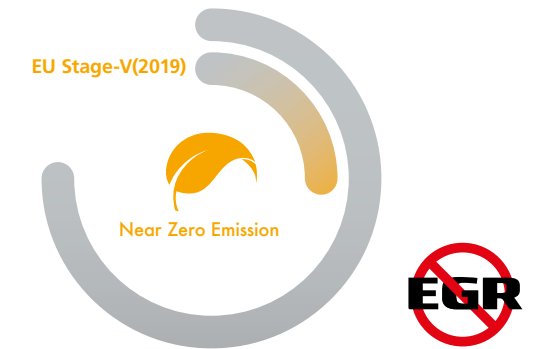

### EPFC System(Electric Positive Flow Control) **NEW**

The advanced hydraulic system and controls based on electric positive flow control system achieve the lowest fuel consumption and improved fine control. Pump power is precisely variable controlled through recognition of lever manipulation amount and specific complex operations.

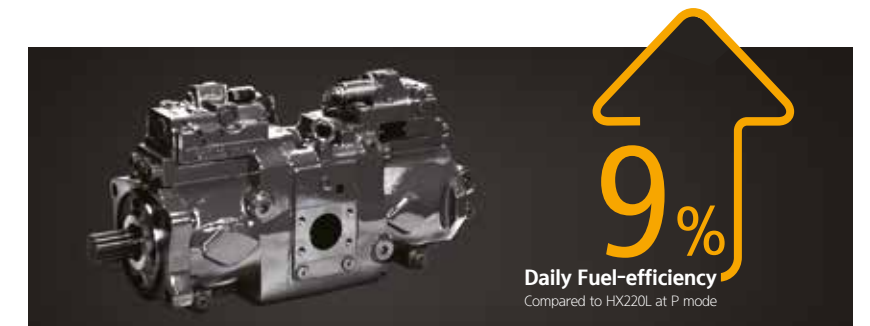

### Lifting Mode **NEW**

This work mode improves fine operability and lift capability through RPM reduction, power boost activation and pump flow control.

\* Photo may include optional equipment





# ULTIMATE DURABILITY

The true value of HX A Series lies in its durability and high productivity. The robust upper and lower frame structure can endure external shock and heavy work loads. Attachment performance has been proven through rigorous field testing. No matter how tough the working environment is, you can always rely on the HYUNDAI Excavator A Series.



**We make the best performance in rough working conditions without any unsureness with trustworthy HX260AL.**



HX A Series is equipment with eco-friendly, high-performance engines that meet the EU Stage V emission requirement. Become a true leader on the ground with HX A Series.

## ROPS / FOG Cabin

The cabin structure of Hyundai HX A Series is using integrally welded low-stress, high strength steel to meet ROPS and FOG certification.

- ROPS : Roll-Over Protective Structures ISO12117-2
- FOG : Falling Object Guard, ISO10262 Level2



## Reinforced Durability of Upper and Lower Structure and Attachments

The upper and lower structure and attachments of HX A Series have higher durability than demanded on the site, as proven through numerous tests including road tests and virtual simulation. The wear resistance of the bucket has been improved by use of new material.

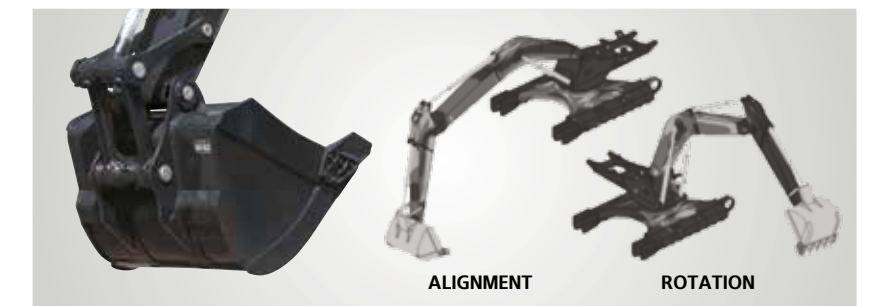

## Durable Cooling Module

HX A Series has a durable cooling module that passed stringent tests, demonstrating the highest productivity in tough working environments.

## Side Protector Option

Protect sides frame during operation in narrow area

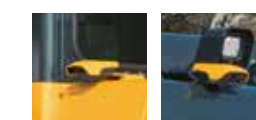

\* The shape of the camera and Lamp guard may be changed to improve the performance of the equipment.

Photo may include optional equipment.



13%

CABIN SPACE FOR DRIVERS INCREASED BY  
(Compared to the previous model)



310mm  
340mm

# EASY CONTROL AND COMFORTABLE OPERATION

Many electronic functions are concentrated in the most convenient spot for operators to improve work efficiency. The highly-advanced infotainment system, a product of HCE's intensive information technology development, enables both productivity and comfort while working! HX A Series is designed with the operator in mind.

## Intelligent & Wide Cluster

The 8" capacitive-type display(like smartphone display) of HX A Series is delivering excellent legibility. The centralized switches on the display allow convenience of checking the urea level and temperature outside the cabin.

## One Pedal Travel Straight Option

One Pedal straight Travel is available for customers' convenience when long distance traveling or combination of attachment work with traveling is necessary.



## Proportional Auxiliary Hydraulic System Option

Proportional control switch with better speed control helps operators to enlarge the operation convenience whenever they do time-consuming work. And this function can be switched with pedal valve in cluster setting menu.

## Jog Dial Module

The integrated jog dial module applies to the accelerator, remote air conditioner controller and operation of the cluster, allowing convenient operation. In the event of failure of the jog dial module, the emergency mode is activated on the cluster to ensure fail-safe function.



\* The arrangement of switches can be changed to increase customer convenience.

## Key On initial Work Mode NEW

Operator can maintain previously set about attachment mode when starting.



## Visibility and Handle Improvement NEW

Visibility through cabin door is improved and handle design on the cabin door is also improved and offers better convenient while operator get on and off the cabin.



## OME(Owner Menu Editing)

The Owner of machine can restrict operators access the set of functions. In the menu. Owner can set the list of the function to lock or unlock it. It is necessary to input the password to access the set of function.



## Combination Speed

Operator can set load sensitivity level, boom priority level against arm and swing. Load sensitivity is controlled by 5 levels of initial flow rate for boom-up and arm in operation according to attachment weight. Boom priority against arm and swing can be set 10 levels of boom priority against arm and swing.

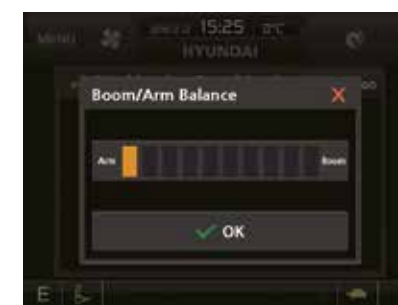

## Fine (Cushion/Free) Swing Control Option

This option enables smooth movement at the start and stop of swing operation(Cushion Swing). In addition, it reduces the shaking of the weight when lifting operation(Free Swing).





## HX260AL with advanced technology ensures our safety on a construction site.



HX A Series excavators are products of HCE's spirit of initiative, creativity, and strong drive. HCE engineers, who are the best in the industry, have worked tirelessly to offer a zero-defect product. The new HX A Series reflects customers' needs in the field gleaned by thorough monitoring.

### AAVM(Advanced Around View Monitoring) Camera System **Option**

HX A Series has a state-of-the-art AAVM video camera system to secure field of vision for operators in all directions, thereby preventing accidents. Operators can easily check the workplace in the front and rear and to the right and left.

- **AAVM**(Advanced Around View Monitoring) : Secure field of vision in all directions by nine views including 3D bird's eye view and 2D/4CH view.
- **IMOD**(Intelligent Moving Object Detection) : Inform when people or dangerous objects are detected within the range of operation(recognition distance : 5 m).

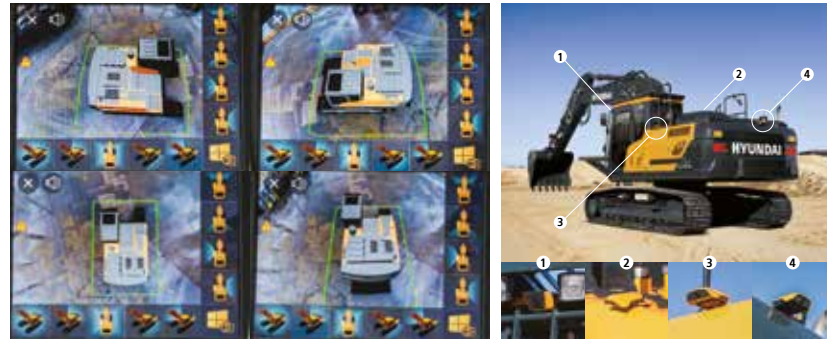

\* The shape of the camera and Lamp guard may be changed to improve the performance of the equipment.

### Auto Safety Lock **NEW**

It prevents unintended operation. If operator unlock safety lever when RCV lever is pressed, excavator is not controlled by RCV lever.

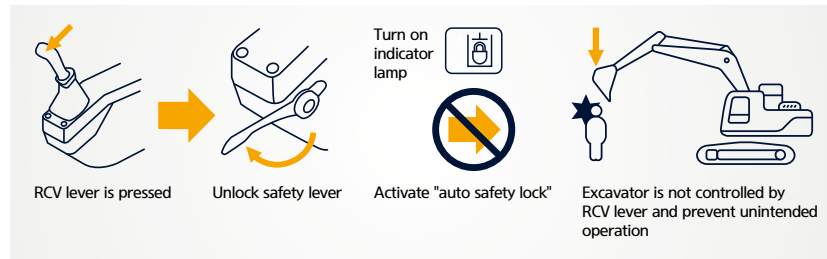

### Seatbelt Warning Alarm

If the seatbelt is not buckled when the ignition key is turned, an alarm is triggered in intervals along with a continuous visual alert. This emphasises our priority for operator safety.

### Electronic Swing Parking System **NEW**

An electronic valve and control system is applied to improve safety and utilization. The opening and closing time of the swing brake valve is controlled according to the sensing and control system.



# THE ULTIMATE SAFE ENVIRONMENT

The true value of HX A Series lies in its durability.

The robust frame structure and the attachments show the real value of HX A Series in tough working environments and promise higher productivity.

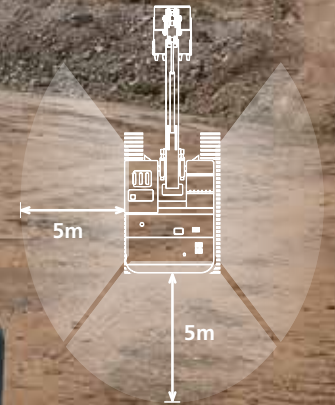





# SERVICEABILITY AND TELEMATICS

IoT / ICT / AI-based digital technology. Creating a smart construction site. Maximizes connectivity, productivity, and safety for successful businesses.



## HiMATE

Option

### IT'S CONVENIENT, EASY AND VALUABLE

Hi-MATE Hyundai's newly developed remote management system, utilizes GPS-satellite technology to provide customers with the highest level of service and product support available. Hi-MATE enables users to remotely evaluate machine performance, access diagnostic information, and verify machine locations at the touch of a button.

### WHAT IS BENEFITS



#### Increase Productivity

It helps you operate machines in efficient. You can check the difference between total engine hours and actual working hours. See how productive your machines are and plan any required cost saving solutions. Hi-MATE offers working information such as working / idling hours, fuel consumption and rate.



#### Convenient and Easy Monitoring

There is nothing much to do to monitor your machines. Just log on to the Hi-MATE website or mobile application. Hi-MATE allows you to watch your machines whenever and wherever you are.



#### Security

Protect your machines from theft or unauthorized usage with Hi-MATE. If the machine moves out of the Geo-fence boundary, you will get alerts.

### ECD(Engine Connected Diagnostics) **NEW**

It supports service technician with remote diagnostics report and ensure it arrive on site with proper tools after preparing in advance.

#### We are all connected

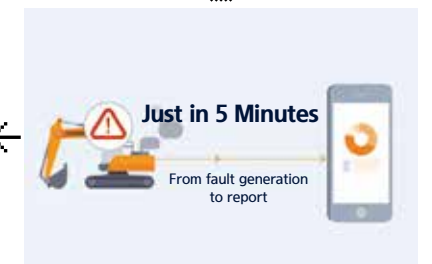
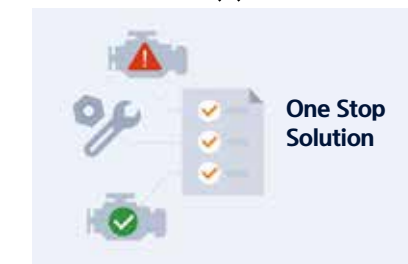

### 2x Longer Lasting Fuel Filter (1,000hr)

The service interval of engine-oil and fuel filters has been increased from 500 hours to 1,000 hours, only the interval of engine-oil is from 500 hours to 800 hours. Regular ash cleaning for DPF is not necessary, only needed as indicated by fault-indicator lamp.



### Urea Tank Cover **Upgrade**

Urea Tank Cover with full open type help operator fill urea into the tank directly and more conveniently.



### Mobile Fleet App.

The new Mobile App is optimized to fleet management. It provides productivity, health insights based on telematics technology and enables fleet owner just focus on most wanted equipment in view of economical usage, utilization, fault codes and maintenance. The new Mobile App sorts equipment in order of eco-index, utilization-index and fault code level automatically so that urgent equipment pops up automatically.

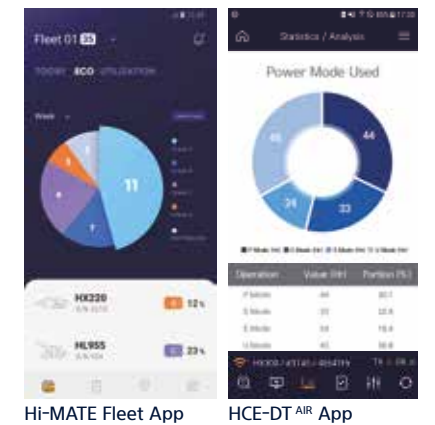

### Connected Diagnostics

Engine connected diagnostics is a kind of cooperated remote diagnostics service between Cummins cloud and Hi-MATE cloud. It enables you get engine diagnostics report by cloud based fault code analysis in real-time and prepare parts, tools necessary in advance. It will help increase first visit fix rates.

\*Photo may include optional equipment.



# SPECIFICATIONS

## ENGINE

Item	Specification
Maker / Model	CUMMINS / B6.7
Type	4 cylinder, watercooled, 4-cycle, turbocharged charge aircooled, direct injection, electronic controlled diesel engine
Gross Power	173kW (232hp) at 2,000rpm
Net Power	169kW (227hp) at 2,000rpm
Max. Power	173kW (232hp) at 2,000rpm
Peak Torque	949 N · m (700 lb · ft) at 1,500 rpm
Displacement	6.7 ℓ (408 cu in)

## HYDRAULIC SYSTEM

### MAIN PUMP

Type	Variable Displacement Tandem Axis Piston Pumps
Max. Flow	2 × 221 ℓ /min
Sub-Pump For Pilot Circuit	Gear Pump

Cross-sensing and fuel saving pump system.

### HYDRAULIC MOTORS

Travel	Two speed axial pistons motor with brake valve and parking brake
Swing	Axial piston motor with automatic brake

### RELIEF VALVE SETTING

Implement Circuits	350 kgf/cm <sup>2</sup> (4,980 psi)
Travel	350 kgf/cm <sup>2</sup> (4,980 psi)
Power Boost (Boom, Arm, Bucket)	380 kgf/cm <sup>2</sup> (5,400 psi)
Swing Circuit	300 kgf/cm <sup>2</sup> (4,267 psi)
Pilot Circuit	40 kgf/cm <sup>2</sup> (570psi)
Service Valve	Installed

### HYDRAULIC CYLINDERS

Boom cylinder	∅135×1,395 mm
Arm cylinder	∅145×1,620 mm
Arm cylinder (2-piece boom)	∅145×1,620 mm
Adjust cylinder (2-piece boom)	∅160×1,230 mm
Bucket cylinder	∅130×1,185 mm

\* Hyundai Bio Hydraulic Oil (HBHO) available.

## DRIVES & BRAKES

Drive Method	Fully Hydrostatic Type
Drive Motor	Axial Piston Motor, In-Shoe Design
Reduction System	Planetary Reduction Gear
Max. Drawbar Pull	22,190 kgf (48,930 lbf)
Max. Travel Speed (High / Low)	5.6 km/hr (3.5 mph) / 3.3 km/hr (2.0 mph)
Gradeability	35° (70%)
Parking Brake	Multi Wet Disc

## CONTROL

Pilot pressure operated joysticks and pedals with detachable lever provide almost effortless and fatigueless operation.

Pilot Control	Two Joysticks with One Safety Lever (LH): Swing and Arm (RH): Boom and Bucket
Traveling And Steering	Two Levers With Pedals
Engine Throttle	Electric, Dial Type

## SWING SYSTEM

Swing Motor	Fixed Displacement Axial Piston Motor
Swing Reduction	Planetary Gear Reduction
Swing Bearing Lubrication	Grease-Bathed
Swing Brake	Multi Wet Disc
Swing Speed	11.2 rpm

## CAPACITIES

	liter	US gal	UK gal
Fuel Tank	450	119	99
Engine Coolant	40	10.6	8.8
Engine Oil	23.1	6.1	5.1
Swing Device	6.2	1.64	1.36
Final Drive (Each)	4.5	1.2	1
Hydraulic System (Including Tank)	275	72.6	60.5
Hydraulic Tank	155	40.1	34.1
DEF/AdBlue®	27	7.1	5.9

## UNDERCARRIAGE

The X-leg type center frame is integrally welded with reinforced box-section track frames. The undercarriage includes lubricated rollers, idlers, track adjusters with shock absorbing springs and sprockets, and a track chain with double or triple grouser shoes.

Center Frame	X - Leg Type
Track Frame	Pentagonal Box Type
No. of Shoes on Each Side	51 EA
No. of Carrier Roller on Each Side	2 EA
No. of Track Roller on Each Side	9 EA
No. of Rail Guard on Each Side	2 EA

## OPERATING WEIGHT (APPROXIMATE)

Operating weight, including 5.85m (19' 2") boom, 3.05m (10' 0") arm, SAE heaped 1.08 m<sup>3</sup> (1.40 yd<sup>3</sup>) bucket, lubricant, coolant, full fuel tank, full hydraulic tank, and all standard equipments.

### OPERATING WEIGHT

Shoes		Operating Weight	Ground Pressure
Type	Width mm (in)	kg (lb)	kgf/cm <sup>2</sup> (psi)
Triple Grouser	600 (24")	27,000 (59,520)	0.55 (7.81)
	700 (28")	27,310 (60,210)	0.48 (6.77)
	800 (32")	27,600 (60,850)	0.42 (5.99)
	900 (36")	27,910 (61,530)	0.38 (5.39)

## AIR CONDITIONING SYSTEM

The air condition system for the machine contains the fluorinated greenhouse gas with global warming potential of R134a. (Global Warming Potential : 1,430)  
The system hold 0.80kg refrigerant consisting of a CO<sub>2</sub> of 1.14 metric tonnes. For more information, Please refer to the manual.

# DIMENSIONS & WORKING RANGE

## HX260A L / HX260A NL MONO BOOM DIMENSIONS

5.85 m (19' 2") MONO BOOM and 3.05 m (10' 0"), 2.1 m (6' 11"), 2.5 m (8' 2"), 3.6 m (11' 10") ARM

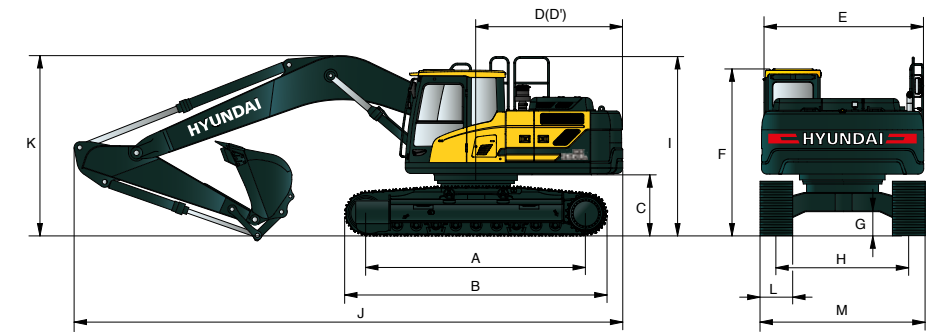

Unit : mm (ft - in)

A Tumbler Distance	3,830 (12' 7")
B Overall Length of Crawler	4,640 (15' 3")
C Ground Clearance of Counter weight	1,110 (3' 8")
D Tail Swing Radius	3,085 (10' 1")
D' Rear-End Length	2,990 (9' 10")
E Overall Width of Upperstructure	2,840 (9' 4")
F Overall Height of Cab	3,050 (10' 0")
G Min. Ground Clearance	480 (1' 7")
H Track Gauge	HX260A L 2,580 (8' 6")
	HX260A NL 2,380 (7' 10")
I Overall Height of Guardrail	3,260 (10' 8")

\* This figure includes the size of grousers.

Boom Length	5.85 (19' 2")				
Arm Length	3.05 (10' 0")	2.1 (6' 11")	2.5 (8' 2")	3.6 (11' 10")	
J Overall Length	10,040 (32' 11")	10,170 (33' 4")	10,120 (33' 2")	10,030 (32' 11")	
K Overall Height of Boom	3,220 (10' 7")	3,530 (11' 7")	3,590 (11' 9")	3,590 (11' 9")	
L Track Shoe Width	TRIPLE GROUSER				
	600 (1' 12")	700 (2' 4")	800 (2' 7")	900 (2' 11")	
	M Overall Width	HX260A L	3,180 (10' 5")	3,280 (10' 9")	3,380 (11' 1")
		HX260A NL	2,980 (9' 9")	3,080 (10' 1")	3,180 (10' 5")

## HX260A L / HX260A NL MONO BOOM WORKING RANGE

Unit : mm (ft - in)

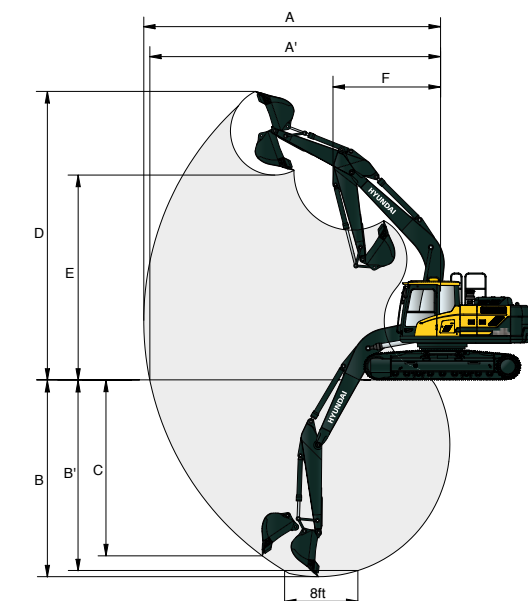

Boom Length	5.85 (19' 2")			
Arm Length	3.05 (10' 0")	2.1 (6' 11")	2.5 (8' 2")	3.6 (11' 10")
A Max. Digging Reach	10,360 (34' 0")	9,550 (31' 4")	9,870 (32' 5")	10,870 (35' 8")
A' Max. Digging Reach on Ground	10,190 (33' 5")	9,360 (30' 9")	9,680 (31' 9")	10,700 (35' 1")
B Max. Digging Depth	7,000 (23' 0")	6,050 (19' 10")	6,450 (21' 2")	7,550 (24' 9")
B' Max. Digging Depth (8' Level)	6,830 (22' 5")	5,840 (19' 2")	6,260 (20' 6")	7,400 (24' 3")
C Max. Vertical Wall Digging Depth	6,150 (20' 2")	5,480 (18' 0")	5,640 (18' 6")	6,830 (22' 5")
D Max. Digging Height	9,670 (31' 9")	9,450 (31' 0")	9,460 (31' 0")	9,920 (32' 7")
E Max. Dumping Height	6,630 (21' 9")	6,360 (20' 10")	6,420 (21' 1")	6,860 (22' 6")
F Min. Swing Radius	3,980 (13' 1")	4,420 (14' 6")	4,200 (13' 9")	3,900 (12' 10")



# DIMENSIONS & WORKING RANGE

## HX260A L / HX260ANL 2-PIECE BOOM DIMENSIONS

5.9 m (19' 4") MONO BOOM and 3.05 m (10' 0"), 2.1 m (6' 11"), 2.5 m (8' 2") ARM

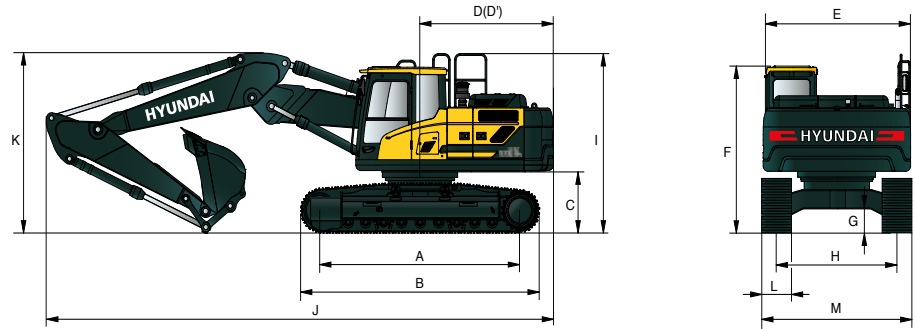

Unit : mm (ft - in)

A	Tumbler Distance	3,830 (12' 7")
B	Overall Length of Crawler	4,640 (15' 3")
C	Ground Clearance of Counter weight	1,110 (3' 8")
D	Tail Swing Radius	3,085 (10' 1")
D'	Rear-End Length	2,990 (9' 10")
E	Overall Width of Upperstructure	2,840 (9' 4")
F	Overall Height of Cab	3,050 (10' 0")
G	Min. Ground Clearance	480 (1' 7")
H	Track Gauge	HX260AL 2,580 (8' 6")
		HX260ANL 2,380 (7' 10")
I	Overall Height of Guardrail	3,260 (10' 8")

Boom Length		5,85 (19' 2")			
Arm Length		3.05 (10' 0")	2.1 (6' 11")	2.5 (8' 2")	3.6 (11' 10")
J	Overall Length	10,040 (32' 11")	10,170 (33' 4")	10,120 (33' 2")	10,030 (32' 11")
K	Overall Height of Boom	3,220 (10' 7")	3,530 (11' 7")	3,590 (11' 9")	3,590 (11' 9")
L	Track Shoe Width	TRIPLE GROUSER			
		600 (1' 12")	700 (2' 4")	800 (2' 7")	900 (2' 11")
M	Overall Width	HX260AL 3,180 (10' 5")	3,280 (10' 9")	3,380 (11' 1")	3,480 (11' 5")
		HX260ANL 2,980 (9' 9")	3,080 (10' 1")	3,180 (10' 5")	

\* This figure includes the size of grousers.

## HX260A L / HX260ANL 2-PIECE BOOM WORKING RANGE

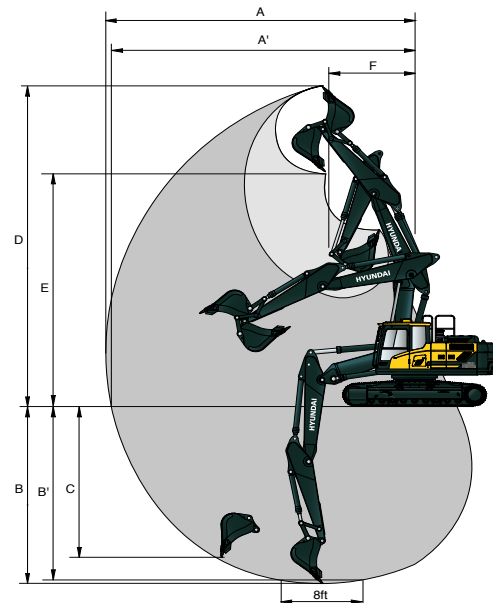

Unit : mm (ft - in)

Boom Length		5,85 (19' 2")			
Arm Length		3.05 (10' 0")	2.1 (6' 11")	2.5 (8' 2")	3.6 (11' 10")
A	Max. Digging Reach	10,360 (34' 0")	9,550 (31' 4")	9,870 (32' 5")	10,870 (35' 8")
		A' Max. Digging Reach on Ground	10,190 (33' 5")	9,360 (30' 9")	9,680 (31' 9")
B	Max. Digging Depth	7,000 (23' 0")	6,050 (19' 10")	6,450 (21' 2")	7,550 (24' 9")
		B' Max. Digging Depth (8' Level)	6,830 (22' 5")	5,840 (19' 2")	6,260 (20' 6")
C	Max. Vertical Wall Digging Depth	6,150 (20' 2")	5,480 (18' 0")	5,640 (18' 6")	6,830 (22' 5")
D	Max. Digging Height	9,670 (31' 9")	9,450 (31' 0")	9,460 (31' 0")	9,920 (32' 7")
		E Max. Dumping Height	6,630 (21' 9")	6,360 (20' 10")	6,420 (21' 1")
F	Min. Swing Radius	3,980 (13' 1")	4,420 (14' 6")	4,200 (13' 9")	3,900 (12' 10")

# LIFTING CAPACITY

Rating over-front Rating over-side or 360 degree

## HX260A L MONO BOOM

Boom 5.85 m (19' 2") / Arm 2.1 m (6' 11") / CWT 4,600kg / Shoe 600mm (24") triple grouser

Lift-point height (m/ft)	Lift-point radius								At max. reach			
	3.0 m (9.8 ft)		4.5 m (14.8 ft)		6.0 m (19.7 ft)		7.5 m (24.6 ft)		Capacity			
7.5m / 24.6ft	kg / lb								*7,270 / *7,270	5.55 (18.2)		
6.0m / 19.7ft	kg / lb			*7,460 / *7,460	*7,010 / 6,810				*7,100 / 5,540	6.77 (22.2)		
4.5m / 14.8ft	kg / lb			*9,290 / *20,480	*9,290 / *20,480	*7,660 / *16,890	6,580 / 14,510		6,940 / 15,300	4,610 / 10,160	7.49 (24.6)	
3.0m / 9.8ft	kg / lb				*8,710 / *19,200	6,260 / 13,800	6,810 / 15,010	4,490 / 9,900	6,320 / 13,930	4,170 / 9,190	7.86 (25.8)	
1.5m / 4.9ft	kg / lb				9,330 / 20,570	5,970 / 13,160	6,670 / 14,700	4,360 / 9,610	6,140 / 13,540	4,030 / 8,880	7.93 (26.0)	
0.0m / 0.0ft	kg / lb			*14,080 / *31,040	8,760 / 19,310	9,150 / 20,170	5,810 / 12,810	6,590 / 14,530	4,290 / 9,460	6,340 / 13,980	4,140 / 9,130	7.70 (25.3)
-1.5m / -4.9ft	kg / lb			*13,680 / *30,160	8,790 / 19,380	9,120 / 20,110	5,780 / 12,740		7,070 / 15,590	4,590 / 10,120	7.16 (23.5)	
-3.0m / -9.8ft	kg / lb	*16,680 / *36,770	*16,680 / *36,770	*12,330 / *27,180	8,960 / 19,750	*9,030 / *19,910	5,940 / 13,100		*8,540 / *18,830	5,700 / 12,570	6.20 (20.4)	
-4.5m / -14.8ft	kg / lb											

Boom 5.85 m (19' 2") / Arm 2.5 m (8' 2") / CWT 4,600kg / Shoe 600mm (24") triple grouser

Lift-point height (m/ft)	Lift-point radius								At max. reach			
	3.0 m (9.8 ft)		4.5 m (14.8 ft)		6.0 m (19.7 ft)		7.5 m (24.6 ft)		Capacity			
7.5m / 24.6ft	kg / lb								*6,080 / *6,080	6.00 (19.7)		
6.0m / 19.7ft	kg / lb				*6,490 / *14,310	*6,490 / *14,310			*5,660 / *12,480	5,130 / 11,310	7.14 (23.4)	
4.5m / 14.8ft	kg / lb			*8,570 / *18,890	*8,570 / *18,890	*7,220 / *15,920	6,650 / 14,660	*6,700 / *14,770	4,650 / 10,250	*5,580 / *12,300	4,320 / 9,520	7.82 (25.7)
3.0m / 9.8ft	kg / lb			*11,080 / *24,430	9,640 / 21,250	*8,340 / *18,390	6,310 / 13,910	6,840 / 15,080	4,510 / 9,940	*5,740 / *12,650	3,930 / 8,660	8.18 (26.8)
1.5m / 4.9ft	kg / lb			*13,120 / *28,920	9,020 / 19,890	9,370 / 20,660	6,000 / 13,230	6,670 / 14,700	4,360 / 9,610	5,780 / 12,740	3,790 / 8,360	8.25 (27.1)
0.0m / 0.0ft	kg / lb			*13,980 / *30,820	8,760 / 19,310	9,150 / 20,170	5,800 / 12,790	6,560 / 14,460	4,260 / 9,390	5,950 / 13,120	3,880 / 8,550	8.03 (26.3)
-1.5m / -4.9ft	kg / lb	*11,520 / *25,400	*11,520 / *25,400	*13,860 / *30,560	8,730 / 19,250	9,080 / 20,020	5,740 / 12,650	6,550 / 14,440	4,260 / 9,390	6,540 / 14,420	4,250 / 9,370	7.51 (24.6)
-3.0m / -9.8ft	kg / lb	*17,870 / *39,400	17,830 / 39,310	*12,810 / *28,240	8,860 / 19,530	9,180 / 20,240	5,830 / 12,850		7,980 / 17,590	5,140 / 11,330	6.61 (21.7)	
-4.5m / -14.8ft	kg / lb			*10,080 / *22,220	9,220 / 20,330				*8,510 / *18,760	7,660 / 16,890	5.12 (16.8)	

1 | 1 Lifting capacity are based on ISO 10567.

1 | 2 Lifting capacity of the HX Series does not exceed 75% of tipping load with the machine on firm, level ground or 87% of full hydraulic capacity.

1 | 3 The Lift-point is bucket pivot mounting pin on the arm(without bucket mass).

1 | 4 (\*) indicates load limited by hydraulic capacity.



# LIFTING CAPACITY

Rating over-front Rating over-side or 360 degree

## HX260A L MONO BOOM

Boom 5.85 m (19' 2") / Arm 3.05 m (10' 0") / CWT 4,600kg / Shoe 600mm (24") triple grouser

Lift-point height (m/ft)	Lift-point radius										At max. reach		
	1.5 m (4.9 ft)		3.0 m (9.8 ft)		4.5 m (14.8 ft)		6.0 m (19.7 ft)		7.5 m (24.6 ft)		Capacity		Reach
													m (ft)
7.5m	kg												
24.6ft	lb												
6.0m	kg												
19.7ft	lb												
4.5m	kg												
14.8ft	lb												
3.0m	kg												
9.8ft	lb												
1.5m	kg												
4.9ft	lb												
0.0m	kg												
0.0ft	lb												
-1.5m	kg												
-4.9ft	lb												
-3.0m	kg												
-9.8ft	lb												
-4.5m	kg												
-14.8ft	lb												

Boom 5.85 m (19' 2") / Arm 3.6 m (11' 10") / CWT 4,600kg / Shoe 600mm (24") triple grouser

Lift-point height (m/ft)	Lift-point radius										At max. reach				
	1.5 m (4.9 ft)		3.0 m (9.8 ft)		4.5 m (14.8 ft)		6.0 m (19.7 ft)		7.5 m (24.6 ft)		9.0m (29.5ft)		Capacity		Reach
															m (ft)
9.0m	kg														
29.5ft	lb														
7.5m	kg														
24.6ft	lb														
6.0m	kg														
19.7ft	lb														
4.5m	kg														
14.8ft	lb														
3.0m	kg														
9.8ft	lb														
1.5m	kg														
4.9ft	lb														
0.0m	kg														
0.0ft	lb														
-1.5m	kg														
-4.9ft	lb														
-3.0m	kg														
-9.8ft	lb														
-4.5m	kg														
-14.8ft	lb														
-6.0m	kg														
-19.7ft	lb														

Boom 5.85 m (19' 2") / Arm 3.05 m (10' 0") / CWT 4,600kg / Shoe 800mm (32") triple grouser

Lift-point height (m/ft)	Lift-point radius										At max. reach		
	1.5 m (4.9 ft)		3.0 m (9.8 ft)		4.5 m (14.8 ft)		6.0 m (19.7 ft)		7.5 m (24.6 ft)		Capacity		Reach
													m (ft)
7.5m	kg												
24.6ft	lb												
6.0m	kg												
19.7ft	lb												
4.5m	kg												
14.8ft	lb												
3.0m	kg												
9.8ft	lb												
1.5m	kg												
4.9ft	lb												
0.0m	kg												
0.0ft	lb												
-1.5m	kg												
-4.9ft	lb												
-3.0m	kg												
-9.8ft	lb												
-4.5m	kg												
-14.8ft	lb												

- 1 | Lifting capacity are based on ISO 10567.
- 2 | Lifting capacity of the HX Series does not exceed 75% of tipping load with the machine on firm, level ground or 87% of full hydraulic capacity.
- 3 | The Lift-point is bucket pivot mounting pin on the arm(without bucket mass).
- 4 | (\*) indicates load limited by hydraulic capacity.

Rating over-front Rating over-side or 360 degree

## HX260A L 2-PIECE BOOM

Boom 5.90 m (19' 4") / Arm 2.1 m (6' 11") / CWT 6,100kg / Shoe 600mm (24") triple grouser

Lift-point height (m/ft)	Lift-point radius										At max. reach	
	3.0 m (9.8 ft)		4.5 m (14.8 ft)		6.0 m (19.7 ft)		7.5 m (24.6 ft)		Capacity		Reach	
											m (ft)	
9.0m	kg											
29.5ft	lb											
7.5m	kg											
24.6ft	lb											
6.0m	kg											
19.7ft	lb											
4.5m	kg											
14.8ft	lb											
3.0m	kg											
9.8ft	lb											
1.5m	kg											
4.9ft	lb											
0.0m	kg											
0.0ft	lb											
-1.5m	kg											
-4.9ft	lb											
-3.0m	kg											
-9.8ft	lb											

Boom 5.90 m (19' 4") / Arm 2.5 m (8' 2") / CWT 6,100kg / Shoe 600mm (24") triple grouser

Lift-point height (m/ft)	Lift-point radius										At max. reach	
	3.0 m (9.8 ft)		4.5 m (14.8 ft)		6.0 m (19.7 ft)		7.5 m (24.6 ft)		Capacity		Reach	
											m (ft)	
9.0m	kg											
29.5ft	lb											
7.5m	kg											
24.6ft	lb											
6.0m	kg											
19.7ft	lb											
4.5m	kg											
14.8ft	lb											
3.0m	kg											
9.8ft	lb											
1.5m	kg											
4.9ft	lb											
0.0m	kg											
0.0ft	lb											
-1.5m	kg											
-4.9ft	lb											
-3.0m	kg											
-9.8ft	lb											

Boom 5.90 m (19' 4") / Arm 3.05 m (10' 0") / CWT 6,100kg / Shoe 600mm (24") triple grouser

Lift-point height (m/ft)	Lift-point radius										At max. reach		
	3.0 m (9.8 ft)		4.5 m (14.8 ft)		6.0 m (19.7 ft)		7.5 m (24.6 ft)		9.0 m (29.5 ft)		Capacity		Reach
													m (ft)
9.0m	kg												
29.5ft	lb												
7.5m	kg												
24.6ft	lb												
6.0m	kg												
19.7ft	lb												
4.5m	kg												
14.8ft	lb												
3.0m	kg												
9.8ft	lb												
1.5m	kg												
4.9ft	lb												
0.0m	kg												
0.0ft	lb												
-1.5m	kg												
-4.9ft	lb												
-3.0m	kg												
-9.8ft	lb												

- 1 | Lifting capacity are based on ISO 10567.
- 2 | Lifting capacity of the HX Series does not exceed 75% of tipping load with the machine on firm, level ground or 87% of full hydraulic capacity.
- 3 | The Lift-point is bucket pivot mounting pin on the arm(without bucket mass).
- 4 | (\*) indicates load limited by hydraulic capacity.













# LIFTING CAPACITY











 Rating over-front  Rating over-side or 360 degree

## HX260A NL MONO BOOM

Boom 5.85 m (19' 4") / Arm 2.1 m (6' 11") / CWT 6,100kg / Shoe 600mm (24") triple grouser

Lift-point height (m/ft)	Lift-point radius								At max. reach			
	3.0 m (9.8 ft)		4.5 m (14.8 ft)		6.0 m (19.7 ft)		7.5 m (24.6 ft)		Capacity		Reach	
											m (ft)	
7.5m 24.6ft	kg lb								*7,280 *16,050	*7,280 *16,050	5.50 (18.1)	
6.0m 19.7ft	kg lb			*7,430 *16,380	*7,430 *16,380	*7,000 *15,430	6,570 14,480		*7,110 *15,670	5,390 11,880	6.74 (22.1)	
4.5m 14.8ft	kg lb			*9,220 *20,330	*9,220 *20,330	*7,630 *16,820	6,350 14,000		*7,160 *15,790	4,470 9,850	7.47 (24.5)	
3.0m 9.8ft	kg lb					*8,680 *19,140	6,030 13,290	7,100 15,650	4,350 9,590	6,600 14,550	4,040 8,910	7.85 (25.8)
1.5m 4.9ft	kg lb					*9,680 *21,340	5,750 12,680	6,960 15,340	4,220 9,300	6,400 14,110	3,890 8,580	7.93 (26.0)
0.0m 0.0ft	kg lb			*14,080 *31,040	8,340 18,390	9,540 21,030	5,590 12,320	6,870 15,150	4,140 9,130	6,610 14,570	3,990 8,800	7.72 (25.3)
-1.5m -4.9ft	kg lb			*13,700 *30,200	8,360 18,430	9,510 20,970	5,560 12,260			7,340 16,180	4,410 9,720	7.18 (23.6)
-3.0m -9.8ft	kg lb	*16,760 *36,950	16,720 36,860	*12,390 *27,320	8,530 18,810	*9,090 *20,040	5,700 12,570			*8,530 *18,810	5,440 11,990	6.24 (20.5)
-4.5m -14.8ft	kg lb											

Boom 5.85 m (19' 2") / Arm 2.5 m (8' 2") / CWT 6,100kg / Shoe 600mm (24") triple grouser

Lift-point height (m/ft)	Lift-point radius								At max. reach			
	3.0 m (9.8 ft)		4.5 m (14.8 ft)		6.0 m (19.7 ft)		7.5 m (24.6 ft)		Capacity		Reach	
											m (ft)	
7.5m 24.6ft	kg lb									*6,100 *13,450	*6,100 *13,450	5.96 (19.5)
6.0m 19.7ft	kg lb					*6,480 *14,290	*6,480 *14,290			*5,660 *12,480	4,990 11,000	7.11 (23.3)
4.5m 14.8ft	kg lb			*8,510 *18,760	*8,510 *18,760	*7,190 *15,850	6,420 14,150	*6,690 *14,750	4,500 9,920	*5,580 *12,300	4,200 9,260	7.81 (25.6)
3.0m 9.8ft	kg lb			*11,010 *24,270	9,210 20,300	*8,300 *18,300	6,080 13,400	7,130 15,720	4,370 9,630	*5,730 *12,630	3,810 8,400	8.17 (26.8)
1.5m 4.9ft	kg lb			*13,080 *28,840	8,600 18,960	*9,400 *20,720	5,780 12,740	6,960 15,340	4,220 9,300	6,030 13,290	3,670 8,090	8.25 (27.1)
0.0m 0.0ft	kg lb			*13,970 *30,800	8,330 18,360	9,540 21,030	5,580 12,300	6,850 15,100	4,110 9,060	6,200 13,670	3,740 8,250	8.04 (26.4)
-1.5m -4.9ft	kg lb	*11,300 *24,910	*11,300 *24,910	*13,880 *30,600	8,300 18,300	9,470 20,880	5,520 12,170	6,840 15,080	4,110 9,060	6,800 14,990	4,090 9,020	7.53 (24.7)
-3.0m -9.8ft	kg lb	*17,940 *39,550	16,500 36,380	*12,860 *28,350	8,430 18,580	*9,540 *21,030	5,600 12,350			8,260 18,210	4,920 10,850	6.64 (21.8)
-4.5m -14.8ft	kg lb	*14,190 *31,280	*14,190 *31,280	*10,200 *22,490	8,770 19,330					*8,510 *18,760	7,210 15,900	5.17 (17.0)

1 | Lifting capacity are based on ISO 10567.

2 | Lifting capacity of the HX Series does not exceed 75% of tipping load with the machine on firm, level ground or 87% of full hydraulic capacity.













3 | The Lift-point is bucket pivot mounting pin on the arm(without bucket mass).

4 | (\*) indicates load limited by hydraulic capacity.













 Rating over-front  Rating over-side or 360 degree

## HX260A NL MONO BOOM

Boom 5.85 m (19' 2") / Arm 3.05 m (10' 0") / CWT 6,100kg / Shoe 600mm (24") triple grouser

Lift-point height (m/ft)	Lift-point radius										At max. reach					
	1.5m (4.9ft)		3.0m (9.8ft)		4.5m (14.8ft)		6.0m (19.7ft)		7.5m (24.6ft)		Capacity		Reach			
													m (ft)			
7.5m 24.6ft	kg lb										*5,640 *12,430	*5,640 *12,430	*4,020 *8,860	*4,020 *8,860	6.62 (21.7)	
6.0m 19.7ft	kg lb							*5,740 *12,650	*5,740 *12,650	*4,610 *10,160	*4,610 *10,160	*3,770 *8,310	*3,770 *8,310	7.68 (25.2)		
4.5m 14.8ft	kg lb					*7,450 *16,420	*7,450 *16,420	*6,520 *14,370	6,490 14,310	*6,110 *13,470	4,530 9,990	*3,720 *8,200	*3,720 *8,200	8.33 (27.3)		
3.0m 9.8ft	kg lb					*9,950 *21,940	9,400 20,720	*7,690 *16,950	6,140 13,540	*6,670 *14,700	4,370 9,630	*3,820 *8,420	3,450 7,610	8.67 (28.4)		
1.5m 4.9ft	kg lb					*12,280 *27,070	8,690 19,160	*8,900 *19,620	5,790 12,760	6,940 15,300	4,190 9,240	*4,080 *8,990	3,320 7,320	8.74 (28.7)		
0.0m 0.0ft	kg lb					*6,220 *13,710	*6,220 *13,710	*13,600 *29,980	8,300 18,300	9,510 20,970	5,540 12,210	6,790 14,970	4,050 8,930	*4,550 *10,030	3,370 7,430	8.54 (28.0)
-1.5m -4.9ft	kg lb	*7,030 *15,500	*7,030 *15,500	*11,040 *24,340	*11,040 *24,340	*13,900 *30,640	8,180 18,030	9,380 20,680	5,430 11,970	6,730 14,840	4,000 8,820	*5,370 *11,840	3,630 8,000	8.06 (26.5)		
-3.0m -9.8ft	kg lb	*11,970 *26,390	*11,970 *26,390	*17,380 *38,320	16,150 35,600	*13,280 *29,280	8,250 18,190	9,410 20,750	5,450 12,020			*6,990 *15,410	4,250 9,370	7.24 (23.8)		
-4.5m -14.8ft	kg lb					*16,090 *35,470	*16,090 *35,470	*11,390 *25,110	8,500 18,740			*8,150 *17,970	5,770 12,720	5.93 (19.5)		

Boom 5.85 m (19' 2") / Arm 3.6 m (11' 10") / CWT 6,100kg / Shoe 600mm (24") triple grouser

Lift-point height (m/ft)	Lift-point radius										At max. reach						
	1.5 m (4.9 ft)		3.0 m (9.8 ft)		4.5 m (14.8 ft)		6.0 m (19.7 ft)		7.5 m (24.6 ft)		9.0 m (29.5 ft)		Capacity		Reach		
															m (ft)		
9.0m 29.5ft	kg lb													*3,970 *8,750	*3,970 *8,750	5.78 (19.0)	
7.5m 24.6ft	kg lb													*3,480 *7,670	*3,480 *7,670	7.28 (23.9)	
6.0m 19.7ft	kg lb									*5,120 *11,290	4,700 10,360			*3,290 *7,250	*3,290 *7,250	8.25 (27.1)	
4.5m 14.8ft	kg lb							*5,840 *12,870	*5,840 *12,870	*5,570 *12,280	4,580 10,100			*3,250 *7,170	*3,250 *7,170	8.86 (29.1)	
3.0m 9.8ft	kg lb					*8,860 *19,530	*8,860 *19,530	*7,060 *15,560	6,210 13,690	*6,190 *13,650	4,390 9,680	*4,220 *9,300	3,240 7,140	*3,330 *7,340	3,130 6,900	9.18 (30.1)	
1.5m 4.9ft	kg lb					*11,390 *25,110	8,820 19,440	*8,360 *18,430	5,820 12,830	*6,910 *15,230	4,190 9,240	*4,880 *10,760	3,150 6,940	*3,540 *7,800	3,010 6,640	9.25 (30.3)	
0.0m 0.0ft	kg lb					*7,000 *15,430	*7,000 *15,430	*13,090 *28,860	8,300 18,300	*9,420 *20,770	5,520 12,170	6,760 14,900	4,020 8,860	*4,350 *9,590	3,070 6,770	*3,900 *8,600	9.06 (29.7)
-1.5m -4.9ft	kg lb	*6,330 *13,960	*6,330 *13,960	*10,390 *22,910	*10,390 *22,910	*13,760 *30,340	8,090 17,840	9,320 20,550	5,360 11,820	6,650 14,660	3,920 8,640			*4,520 *9,960	3,240 7,140	8.61 (28.3)	
-3.0m -9.8ft	kg lb	*10,310 *22,730	*10,310 *22,730	*15,530 *33,730	*15,530 *33,730	*13,520 *29,810	8,090 17,840	9,290 20,480	5,330 11,750	6,670 14,700	3,930 8,660			*5,670 *12,500	3,710 8,180	7.85 (25.8)	
-4.5m -14.8ft	kg lb	*15,330 *33,800	*15,330 *33,800	*17,610 *38,820	16,210 35,740	*12,190 *26,870	8,270 18,230	*8,910 *19,640	5,470 12,060					*7,630 *16,820	4,770 10,520	6.66 (21.9)	
-6.0m -19.7ft	kg lb																

1 | Lifting capacity are based on ISO 10567.

2 | Lifting capacity of the HX Series does not exceed 75% of tipping load with the machine on firm, level ground or 87% of full hydraulic capacity.

3 | The Lift-point is bucket pivot mounting pin on the arm(without bucket mass).

4 | (\*) indicates load limited by hydraulic capacity.



# LIFTING CAPACITY

Rating over-front Rating over-side or 360 degree

## HX260A NL 2-PIECE BOOM

Boom 5.85 m (19' 4") / Arm 2.1 m (6' 11") / CWT 6,100kg / Shoe 600mm (24") triple grouser

Lift-point height (m/ft)		Lift-point radius								At max. reach		
		3.0 m (9.8 ft)		4.5 m (14.8 ft)		6.0 m (19.7 ft)		7.5 m (24.6 ft)		Capacity		Reach
												m (ft)
9.0m 29.5ft	kg lb									*11,550 *25,460	*11,550 *25,460	3.48 (11.4)
7.5m 24.6ft	kg lb			*8,710 *19,200	*8,710 *19,200					*7,680 *16,930	*7,680 *16,930	5.66 (18.6)
6.0m 19.7ft	kg lb			*9,080 *20,020	*9,080 *20,020	*7,110 *15,670	*7,110 *15,670			*6,500 *14,330	5,680 12,520	6.87 (22.5)
4.5m 14.8ft	kg lb			*10,770 *23,740	10,640 23,460	*7,560 *16,670	6,890 15,190	*6,040 *13,320	4,850 10,690	*6,000 *13,230	4,750 10,470	7.59 (24.9)
3.0m 9.8ft	kg lb					*8,450 *18,630	6,550 14,440	*6,230 *13,730	4,730 10,430	*5,850 *12,900	4,310 9,500	7.96 (26.1)
1.5m 4.9ft	kg lb					*9,540 *21,030	6,240 13,760	*6,550 *14,440	4,600 10,140	*5,970 *13,160	4,170 9,190	8.04 (26.4)
0.0m 0.0ft	kg lb					*9,920 *21,870	6,080 13,400	*6,830 *15,060	4,520 9,960	*6,380 *14,070	4,280 9,440	7.83 (25.7)
-1.5m -4.9ft	kg lb			*11,200 *24,690	9,120 20,110	*8,770 *19,330	6,070 13,380			*6,390 *14,090	4,730 10,430	7.30 (23.9)
-3.0m -9.8ft	kg lb					*61,70 *13,600	*6,170 *13,600					

Boom 5.85 m (19' 4") / Arm 2.5 m (8' 2") / CWT 6,100kg / Shoe 600mm (24") triple grouser

Lift-point height (m/ft)		Lift-point radius								At max. reach		
		3.0 m (9.8 ft)		4.5 m (14.8 ft)		6.0 m (19.7 ft)		7.5 m (24.6 ft)		Capacity		Reach
												m (ft)
9.0m 29.5ft	kg lb									*7,590 *16,730	*7,590 *16,730	4.21 (13.8)
7.5m 24.6ft	kg lb			*8,210 *18,100	*8,210 *18,100	*6,870 *15,150	*6,870 *15,150			*6,130 *13,510	*6,130 *13,510	6.13 (20.1)
6.0m 19.7ft	kg lb			*8,580 *18,920	*8,580 *18,920	*6,770 *14,930	*6,770 *14,930			*5,640 *1,2430	5,250 11,570	7.25 (23.8)
4.5m 14.8ft	kg lb			*10,030 *22,110	*10,030 *22,110	*7,230 *15,940	6,980 15,390	*5,740 *12,650	4,910 10,820	*5,480 *12,080	4,450 9,810	7.94 (26.0)
3.0m 9.8ft	kg lb			*13,030 *28,730	9,970 21,980	*8,100 *17,860	6,610 14,570	*6,000 *13,230	4,760 10,490	*5,370 *11,840	4,060 8,950	8.30 (27.2)
1.5m 4.9ft	kg lb			*13,890 *30,620	9,320 20,550	*9,210 *20,300	6,280 13,850	*6,370 *14,040	4,600 10,140	*5,480 *12,080	3,920 8,640	8.37 (27.5)
0.0m 0.0ft	kg lb			*13,390 *29,520	9,060 19,970	*10,030 *22,110	6,070 13,380	*6,700 *14,770	4,490 9,900	*5,840 *12,870	4,010 8,840	8.17 (26.8)
-1.5m -4.9ft	kg lb	*9,980 *22,000	*9,980 *22,000	*11,870 *26,170	9,050 19,950	*9,140 *20,150	6,020 13,270	*6,690 *14,750	4,490 9,900	*6,330 *13,960	4,380 9,660	7.66 (25.1)
-3.0m -9.8ft	kg lb			*9,270 *20,440	9,210 20,300	*7,080 *15,610	6,120 13,490			*5,470 *12,060	5,240 11,550	6.79 (22.3)

Boom 5.85 m (19' 4") / Arm 3.05 m (10' 0") / CWT 6,100kg / Shoe 600mm (24") triple grouser

Lift-point height (m/ft)		Load radius										At max. reach		
		3.0m (9.8ft)		4.5m (14.8ft)		6.0m (19.7ft)		7.5m (24.6ft)		9.0m (29.5ft)		Capacity		Reach
														m (ft)
9.0m 29.5ft	kg lb			*6,390 *14,090	*6,390 *14,090							*4,740 *10,450	*4,740 *10,450	5.15 (16.9)
7.5m 24.6ft	kg lb					*6,150 *13,560	*6,150 *13,560					*4,010 *8,840	*4,010 *8,840	6.80 (22.3)
6.0m 19.7ft	kg lb			*6,850 *15,100	*6,850 *15,100	*6,330 *13,960	*6,330 *13,960	*5,240 *11,550	5,050 11,130			*3,730 *8,220	*3,730 *8,220	7.83 (25.7)
4.5m 14.8ft	kg lb	*11,820 *26,060	*11,820 *26,060	*9,100 *20,060	*9,100 *20,060	*6,770 *14,930	*6,770 *14,930	*5,400 *11,900	4,950 10,910			*3,650 *8,050	*3,650 *8,050	8.47 (27.8)
3.0m 9.8ft	kg lb			*11,750 *25,900	10,200 22,490	*7,590 *16,730	6,680 14,730	*5,690 *12,540	4,770 10,520			*3,710 *8,180	3,680 8,110	8.81 (28.9)
1.5m 4.9ft	kg lb			*13,610 *30,000	9,430 20,790	*8,690 *19,160	6,300 13,890	*6,080 *13,400	4,580 10,100			*3,910 *8,620	3,560 7,850	8.87 (29.1)
0.0m 0.0ft	kg lb			*13,640 *30,070	9,040 19,930	*9,770 *21,540	6,040 13,320	*6,470 *14,260	4,440 9,790			*4,290 *9,460	3,620 7,980	8.68 (28.5)
-1.5m -4.9ft	kg lb	*10,000 *22,050	*10,000 *22,050	*12,540 *27,650	8,930 19,690	*9,470 *20,880	5,940 13,100	*6,710 *14,790	4,390 9,680			*4,970 *10,960	3,900 8,600	8.21 (26.9)
-3.0m -9.8ft	kg lb			*10,380 *22,880	9,030 19,910	*7,920 *17,460	5,980 13,180					*5,460 *12,040	4,550 10,030	7.41 (24.3)

1 | Lifting capacity are based on ISO 10567.  
 2 | Lifting capacity of the HX Series does not exceed 75% of tipping load with the machine on firm, level ground or 87% of full hydraulic capacity.  
 3 | The Lift-point is bucket pivot mounting pin on the arm(without bucket mass).  
 4 | (\*) indicates load limited by hydraulic capacity.

# BUCKET SELECTION GUIDE & DIGGING FORCE

## BUCKETS

All buckets are welded with high-strength steel.



SAE heaped m <sup>3</sup> (yd <sup>3</sup> )	0.80 (1.05) 0.92 (1.20) 1.10 (1.44) 1.20 (1.57)	1.34 (1.75)	◆ 0.90 (1.18) ◆ 1.05 (1.37)	◆ 0.87 (1.14)	◆ 1.20 (1.57)	★ 0.52 (0.68)
---	--	-------------	--------------------------------	---------------	---------------	---------------

Capacity m <sup>3</sup> (yd <sup>3</sup> )	Width mm (in)	Weight kg (lb)	Tooth (EA)	Recommendation mm (ft.in)							
				5,650 (18' 6") Mono Boom				5,900 (19' 5") Mono Boom			
				2,000 (6' 7") Arm	2,400 (7' 10") Arm	2,920 (9' 7") Arm	3,900 (12' 10") Arm	2,100 (6' 11") Arm	2,500 (8' 2") Arm	3,050 (10' 0") Arm	
(G) 1.08 (1.41)	0.95 (1.24)	1,170 (46.1")	1,020 (2,250)	5	●	●	●	⊙	●	●	●
(G) 1.27 (1.66)	1.11 (1.45)	1,325 (52.2")	1,100 (2,430)	5	●	●	●	⊙	●	⊙	■
(G) 1.50 (1.96)	1.30 (1.70)	1,515 (59.6")	1,180 (2,600)	5	●	●	●	■	⊙	■	▲
(H) 1.27 (1.66)	1.11 (1.45)	1,380 (54.3")	1,290 (2,840)	5	●	⊙	■	▲	●	⊙	■
(H) 1.46 (1.91)	1.28 (1.67)	1,535 (60.4")	1,380 (3,040)	6	⊙	⊙	■	▲	⊙	■	▲
(R) 1.16 (1.52)	1.00 (1.31)	1,285 (50.6")	1,380 (3,040)	5	●	●	●	■	●	⊙	■

(G) General Purpose  
 (H) Heavy Duty  
 (R) Rock-HD

●: Applicable for materials with density of 2,100 kg/m<sup>3</sup> (3,500 lb/yd<sup>3</sup>) or less  
 ⊙: Applicable for materials with density of 1,800 kg/m<sup>3</sup> (3,000 lb/yd<sup>3</sup>) or less  
 ■: Applicable for materials with density of 1,500 kg/m<sup>3</sup> (2,500 lb/yd<sup>3</sup>) or less  
 ▲: Applicable for materials with density of 1,200 kg/m<sup>3</sup> (2,000 lb/yd<sup>3</sup>) or less  
 X: Not Recommended

## ATTACHMENT

Booms and arms are welded with a low-stress, full-box section design.  
 5.65 Mono & 5.65 2-Piece Booms and 2.0 m, 2.4 m, 2.92 m, 3.9 m Arms are available.



# BUCKET SELECTION GUIDE & DIGGING FORCE

HX260A L MONO BOOM DIGGING FORCE							
Boom	Length	mm (ft.in)	5,850 (19' 2")				Remark
	Weight	kg (lb)	2,460 (5,420)				
Arm	Length	mm (ft.in)	2,100 (6' 11")	2,500 (8' 2")	3,050 (10' 0")	3,600 (11' 10")	
	Weight	kg (lb)	1,420 (3,130)	1,450 (3,200)	1,540 (3,400)	1,600 (3,530)	
Bucket Digging Force	SAE	kN	153.1 [166.1]	153.6 [167.2]	154.0 [167.2]	154.1 [167.2]	
		kgf	15,600 [16,940]	15,700 [17,050]	15,700 [17,050]	15,700 [17,050]	
		lbf	34,403 [37,350]	34,522 [37,590]	34,603 [37,590]	34,638 [37,590]	
		kN	177.2 [192.7]	177.8 [192.7]	178.2 [193.8]	178.4 [193.8]	
	ISO	kgf	18,100 [19,650]	18,100 [19,650]	18,200 [19,760]	18,200 [19,760]	
		lbf	39,819 [43,320]	39,957 [43,320]	40,051 [43,560]	40,092 [43,560]	
		SAE	kN	159.2 [172.5]	134.3 [145.8]	113.3 [122.5]	103.1 [111.8]
			kgf	16,200 [17,590]	13,700 [14,870]	11,500 [12,490]	10,500 [11,400]
Arm Crowd Force	SAE	lbf	35,777 [38,780]	30,188 [32,780]	25,461 [27,540]	23,170 [25,130]	
		ISO	kN	167.7 [182.1]	140.8 [153.3]	118.2 [127.8]	107.0 [116.0]
	kgf		17,100 [18,570]	14,400 [15,630]	12,000 [13,030]	10,900 [11,830]	
	lbf	37,698 [40,940]	31,651 [34,460]	26,553 [28,730]	24,056 [26,080]		

Note : Boom weight includes arm cylinder, piping, and pin  
 Arm weight includes bucket cylinder, linkage, and pin

HX260A L 2-PIECE BOOM DIGGING FORCE							
Boom	Length	mm (ft.in)	5,900 (19' 4")				Remark
	Weight	kg (lb)	3,000 (6,610)				
Arm	Length	mm (ft.in)	2,100 (6' 11")	2,500 (8' 2")	3,050 (10' 0")		
	Weight	kg (lb)	1,420 (3,130)	1,450 (3,200)	1,540 (3,400)		
Bucket Digging Force	SAE	kN	153.1 [166.1]	153.6 [167.2]	154.0 [167.2]		
		kgf	15,600 [16,940]	15,700 [17,050]	15,700 [17,050]		
		lbf	34,403 [37,350]	34,522 [37,590]	34,603 [37,590]		
		kN	177.2 [192.7]	177.8 [192.7]	178.2 [193.8]		
	ISO	kgf	18,100 [19,650]	18,100 [19,650]	18,200 [19,760]		
		lbf	39,819 [43,320]	39,957 [43,320]	40,051 [43,560]		
		SAE	kN	159.2 [172.5]	134.3 [145.8]	113.3 [122.5]	
			kgf	16,200 [17,590]	13,700 [14,870]	11,500 [12,490]	
Arm Crowd Force	SAE	lbf	35,777 [38,780]	30,188 [32,780]	25,461 [27,540]		
		ISO	kN	167.7 [182.1]	140.8 [153.3]	118.2 [127.8]	
	kgf		17,100 [18,570]	14,400 [15,630]	12,000 [13,030]		
	lbf	37,698 [40,940]	31,651 [34,460]	26,553 [28,730]			

Note : Boom weight includes arm cylinder, piping, and pin  
 Arm weight includes bucket cylinder, linkage, and pin

# STANDARD / OPTIONAL

ENGINE	STD
Cummins B6.7	●
HYDRAULIC SYSTEM	
Electric Positive Flow Control (EPFC)	
3-Power Mode, 2-Work Mode, User Mode	●
Variable Power Control	●
Pump Flow Control	●
Attachment Mode Flow Control	
Engine Auto Idle	●
Electronic Swing Parking Brake	
Engine Auto Shutdown Control	
Electronic Fan Control	●
Hyundai Bio Hydraulic oil (HBHO)	
CAB & INTERIOR	
ISO Standard cabin	
Rise-Up Type Windshield Wiper	●
Radio / USB Player	●
Handsfree Mobile Phone System with USB	●
12V Power Outlet (24V DC to 12V DC converter)	●
Electric Horn	●
All-Weather Steel Cab with 360° Visibility	●
Safety Glass - Tempered Glass	●
Safety Glass - Laminated Glass, Front Window & Glass	
Sliding Fold-In Front Window	●
Sliding Side Window (LH)	●
Lockable Door	●
Hot & Cool Box	●
Storage Compartment	●
Ashtray & Cigar Lighter	
Transparent Cabin Roof-Cover	●
Sun Visor	●
Door And Cab Locks, One Key	●
Mechanical Suspension Seat With Heater	●
Pilot-Operated Slidable Joystick	●
Console Box Height Adjust System	●
Automatic climate control	
Air Conditioner & Heater	●
Defroster	●
Starting Aid (Air Grid Heater) for Cold Weather	●
Centralized monitoring	
8" LCD Display	●
Engine Speed or Trip Meter / Accel.	●
Engine Coolant Temperature Gauge	●
Max Power	●
Low Speed / High Speed	●
Auto Idle	●
Overload	●
Check Engine	●
Air Cleaner Clogging	●
Indicators	●
ECO Gauges	●
Fuel Level Gauge	●
Hyd. Oil Temperature Gauge	●
Fuel Warmer	●
Warnings	●
Communication Error	●
Low Battery	●
Clock	●
Cabin Lights	
Cabin Front Window Rain Guard	
Cabin Roof-Steel Cover	
Seat	
Adjustable Air Suspension Seat With Heater	
Cabin FOG (ISO 10262) Level 2	
FOG (Falling Object Protective Structure) - ISO 10262 Level 2	
Cabin ROPS	
ROPS (Roll Over Protective Structures) - ISO 1211 7-2	●

SAFETY	STD
Battery Master Switch	●
Rearview Camera	
AAVM (Advanced Around View Monitoring)	
Four Front Working Lights (2 Boom Mounted, 2 Front Frame Mounted)	●
Travel Alarm	●
Rear Work Lamp	
Beacon Lamp	
Automatic Swing Brake	●
Boom Holding System	●
Arm Holding System	●
Safety Lock Valve For Boom Cylinder With Overload Warning Device	
Safety Lock Valve For Arm Cylinder	
Swing Lock System	
Three Outside Rearview Mirror	●
Front Guard - Wire Net	
OTHER	
Booms	
5.85 m, 19' 2"	●
5.90 m, 19' 4"	
Arms	
2.10 m, 6' 11"	
2.50 m, 8' 2"	
3.05 m, 10' 0"	●
3.60 m, 11' 10"	
Removable Clean-Out Dust Net For Cooler	●
Removable Reservoir Tank	●
Fuel Warmer	●
Self-Diagnostics System	●
Hi-MATE (Remote Management System)	
Batteries (2 × 12 V × 100 AH)	●
Fuel Filler Pump (50 ℓ /min)	
Single-Acting Piping Kit (Breaker, Etc.)	
Double-Acting Piping Kit (Clamshell, Etc.)	
2 way Proportional RCV & Pedal control selection	
Rotating Piping Kit	
Quick Coupler Piping	
Quick Coupler	
One Pedal Straight Travel System	
Accumulator For Lowering Work Equipment	●
Pattern Change Valve (2 Patterns)	
Fine Swing Control System	
Tool Kit	
UNDERCARRIAGE	
Lower Frame Under Cover (Additional)	
Lower Frame Under Cover (Normal)	●
Track Shoes	
Triple Grousers Shoes (600 mm, 1' 12")	●
Triple Grousers Shoe (700 mm, 2' 4")	
Triple Grousers Shoe (800 mm, 2' 7")	
Triple Grousers Shoe (900 mm, 2' 11")	
Track Rail Guard	●

\* Standard and optional equipment may vary. Contact your Hyundai dealer for more information. The machine may vary according to International standards.  
 \* The photos may include attachments and optional equipment that are not available in your area.  
 \* Materials and specifications are subject to change without advance notice.  
 \* All imperial measurements rounded off to the nearest pound or inch.



